

OBD

Biscayne Designs

HARDWARE

SELECTIONS



Contemporary. Antique. Transitional. Modern.

| WWW.OLDBISCAYNEDESIGNS.COM |

Hardware

OLD BISCAYNE DESIGNS

Furniture Hardware...

Like jewelry for the home

Defines the last layer of style

For each furniture design.

Within these pages you will discover hardware created using chrome, brushed nickel, antique silver, oil-rubbed bronze, antique pewter, and more. Designs range from old world antiquities to the simplicity of modern styles.

Many designs start as an original lost wax casting, like a fine jewelry design. These pieces are produced in multiples using a method called sand casting. Artisans create chemical patinas refining the delicate shades and hues to enrich the depth of hand cast cracks and crevices. These designs are unique; no two will be exactly the same.

Hardware is cast using semi-precious metals. Each design is only available in the metal pictured. If a customer does not designate a particular hardware, our furniture technicians will apply the hardware that best accentuates the style of the piece or the hardware pictured on the original design.

Each Old Biscayne Finish
Is The Final Signature
Of A Unique Original Design.

Gabrielli '21

OLD BISCAYNE DESIGNS

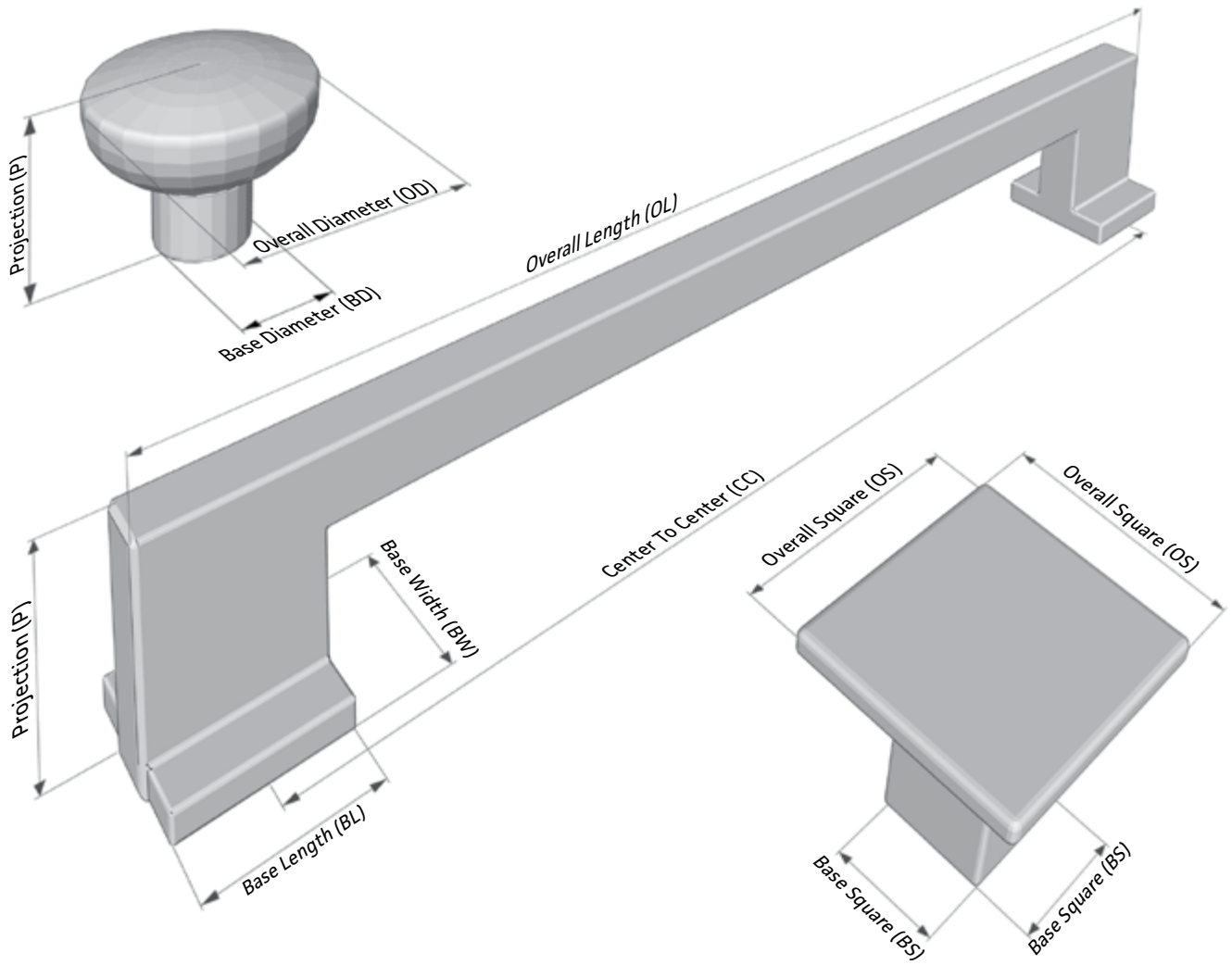

Hardware Reference

OL	Overall Length
OW	Overall Width
OS	Overall Square
OD	Overall Diameter
P	Projection
BL	Base Length
BW	Base Width
BS	Base Square
BD	Base Diameter
CC	Center to Center

OLD BISCAYNE DESIGNS



Louis Small Knob
 ANTIQUE PEWTER
 OD: 7/8" P: 7/8" BD: 3/8"



Louis Medium Knob
 ANTIQUE PEWTER
 OD: 1 1/8" P: 1" BD: 1/2"



Louis Large Knob
 ANTIQUE PEWTER
 OD: 1 1/4" P: 1 1/8" BD: 5/8"



Tuscany Backplate with Knob
 ANTIQUE PEWTER
 L: 2 7/8" W: 7/8"



Louis Backplate with Knob
 ANTIQUE PEWTER
 L: 3 1/4" W: 1 3/8"



**Louis Right & Left
 Backplates with Knob**
 ANTIQUE PEWTER
 L: 6 3/4" W: 1"

 = 1/4 Inch

L Length
 W Width
 OD Overall Diameter
 P Projection
 BD Base Diameter



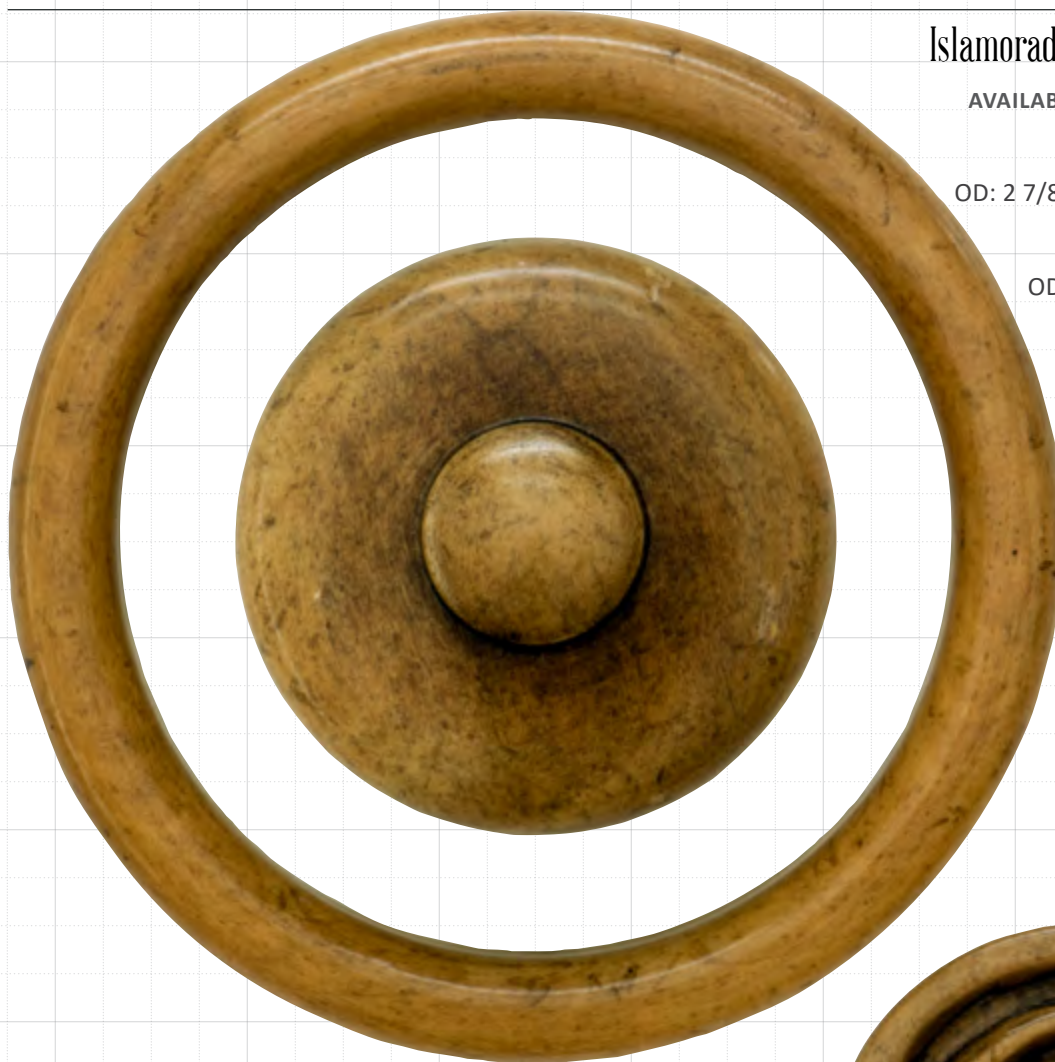

Islamorada Wood Hardware Set

AVAILABLE IN ANY OBD FINISH

Inside Knob

OD: 2 7/8" P: 1 7/8" BD: 1 1/4"

Outer Ring

OD: 5 1/2" P: 1/2"



Cara Wooden Pull

AVAILABLE IN ANY OBD FINISH

OD: 2 3/4" P: 1 1/4" BD: 1 1/4"



Small Wooden Knob

AVAILABLE IN ANY OBD FINISH

OD: 1 1/4" P: 1 1/2" BD: 1"

OD Overall Diameter
P Projection
BD Base Diameter

 = 1/4 Inch



Colbert Knob

AVAILABLE IN ANY OBD FINISH

OL: 2 3/4" P: 2 3/4" OW: 2 3/8" BD: 1 1/4"



Malloy Pull

AVAILABLE IN ANY OBD FINISH

OD: 4 1/2" P: 2 3/4" BD: 2 3/8"

 = 1/4 Inch

OL Overall Length
OW Overall Width
OD Overall Diameter
P Projection
BD Base Diameter



Le Blanc Pull

ANTIQUE PEWTER

Ring D: 2" P: 1/4"

BL: 4 7/8" BW: 2 1/2" CC: 4"



Saborn Pull

RUST

OL: 3 7/8" P: 3/4" OW: 2 1/4"

BL: 1/5" BW: 1/5" CC: 2 1/2"

D | Diameter
P | Projection
OL | Overall Length
OW | Overall Width
BL | Base Length
BW | Base Width
CC | Center to Center

= 1/4 Inch



Banderas Small Pull

ANTIQUPE PEWTER

OL: 2" OW: 1 3/4"

BL: 1 1/2" BW: 1 1/4"



Banderas Knocker

ANTIQUPE BRONZE

OL: 2 3/4" OW: 2 1/2" P: 7/8"

BD: 3/4"



Banderas Large Pull

ANTIQUPE PEWTER

Ring D: 2" P: 1/4"

BL: 3 3/4" BW: 3 3/4"



Banderas Knob

ANTIQUPE BRONZE

OD: 1 1/2" P: 1" BD: 7/8"

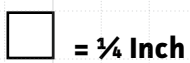



Antoinette Knob

ANTIQUÉ BRONZE
OD: 1" P: 3/4" BD: 1"



Estrella Small Knob

ANTIQUÉ BRONZE
OD: 1 1/4" P: 1" BD: 1 1/4"



Estrella Large Knob

ANTIQUÉ BRONZE
OD: 1 1/2" P: 1" BD: 1 1/2"



Antoinette Pull

ANTIQUÉ BRONZE
OL: 2 1/8" OW: 1 1/2" P: 1/2"
BL: 2" BW 1 1/2"



Mullaney Pull

BRONZE
OD: 2 1/2" P: 1/2" BD: 2 1/2"

OD Overall Diameter
OL Overall Length
OW Overall Width
P Projection
BD Base Diameter
BL Base Length
BW Base Width

 = 1/4 Inch



Ansley Knob

ANTIQUÉ BRONZE & ANTIQUÉ SILVER

OD: 1 1/2" P: 1 1/4" BD: 7/8"



Ansley Pull

ANTIQUÉ BRONZE

OL: 2 1/2" OW: 2" P: 1/2" BD: 2"



Kristina Pull

BRONZE & ANTIQUÉ SILVER

OL: 3.5" OW: 1" P: 3/4" BL: 3"

 = 1/4 Inch

OD | Overall Diameter
OL | Overall Length
OW | Overall Width
P | Projection
BD | Base Diameter
BL | Base Length
BW | Base Width



Robb Large Pull

ANTIQUÉ BRONZE

OL: 9" OW: 3 1/4" P: 1" CC: 4 3/4



Robb Small Pull

ANTIQUÉ BRONZE

OL: 5 1/2" OW: 2 1/2" P: 1" CC: 3 1/2"



OL Overall Length
OW Overall Width
P Projection
CC Center to Center

 = 1/4 Inch

OLD BISCAYNE DESIGNS

Hardware



Vanessa Drop Pull

ANTIQUÉ SILVER & ANTIQUÉ BRONZE

OL: 2 1/4" OW: 1 1/4" P: 3/4" BD: 7/8"



Vanessa False Key

ANTIQUÉ BRONZE

OL: 2 1/2" OW: 1 1/4" P: 1 1/4"



Vanessa Large Pull ANTIQUÉ BRONZE

OL: 5" OW: 2" P: 3/4" BD: 1 1/8" CC: 3 3/4"



Vanessa Small Pull ANTIQUÉ BRONZE

OL: 3 1/2" OW: 1 1/4" P: 3/4" BD: 1" CC: 2 3/4"

 = 1/4 Inch

OL Overall Length
OW Overall Width
P Projection
BD Base Diameter
CC Center to Center



Olga Knob

TARNISHED SILVER & ANTIQUE BRONZE

OD: 1 3/8" P: 1" BD: 1 1/8"



Eva Knob

SILVER & BRONZE

OD: 1 1/2" P: 1 1/4" BD: 1 1/4"



Eloise Knob

SILVER PLATE & BRONZE

OD: 1 1/2" P: 1 1/4" BD: 1 1/4"

OD Overall Diameter
P Projection
BD Base Diameter

 = 1/4 Inch



Barilou Drop Pull

ANTIQUÉ BRONZE

OL: 5" OW: 1 3/4" P: 3/4"

BL: 1 1/4" BW: 1" CC: 3 3/4"



Octavia Small Knob

SATIN NICKEL BASE

OW: 1" P: 1" BD: 3/4"



Octavia Knob

SATIN NICKEL BASE

OW: 1 1/2" P: 1 1/4" BD: 1"



Crystal Knob

STAINLESS STEEL POST

OD: 1 1/4" P: 1 3/4" BD: 3/4"

 = 3/4 Inch

OD	Overall Diameter
OL	Overall Length
OW	Overall Width
P	Projection
BD	Base Diameter
BL	Base Length
BW	Base Width
CC	Center to Center



Sutton 6" Pull

BRUSHED OIL RUBBED BRONZE &
SATIN NICKEL

OL: 6" OW: 3/8" P: 1" BL: 3/4" CC: 5"

OL Overall Length
OW Overall Width
P Projection
BL Base Length
CC Center to Center

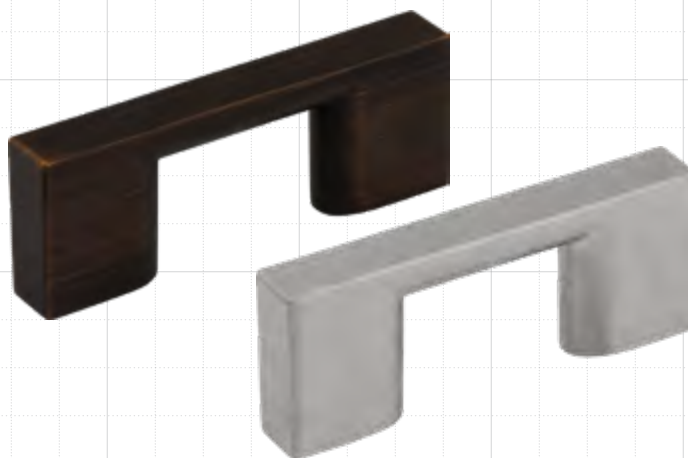

Sutton Knob

BRUSHED OIL RUBBED BRONZE & SATIN NICKEL

OL: 2 1/4" OW: 3/8" P: 1" BL: 5/8" CC: 1 1/4"

Sutton 11 1/2" Pull

BRUSHED OIL RUBBED BRONZE & SATIN NICKEL

OL: 11 1/2" OW: 3/8" P: 1" BL: 1" CC: 10"



 = 1/4 Inch



Cicero Drop Pull

POLISHED NICKEL & POLISHED BRASS

OL: 3 1/8" OW: 2 3/4" P: 1" BL: 1 1/4" BW: 3/4"



Mercer Pull

CHROME

OL: 6.5" OW: 1/4" P: 1 3/4" CC: 3 1/4"



Chicago Pull

ANTIQUÉ SILVER

OL: 12" OW: 1/4" P: 1 3/4" CC: 5 1/4"

 = 3/4 Inch

OL	Overall Length
OW	Overall Width
P	Projection
BD	Base Diameter
BL	Base Length
BW	Base Width
CC	Center to Center



Modena Knob

CHROME

OS: 1" P: 3/4" BS: 1/2"

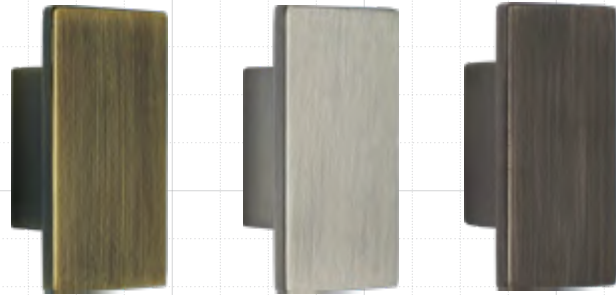

Holmes Knob

ANTIQUE BRUSHED BRASS, BRUSHED NICKEL & BRUSHED PEWTER

OL: 1 1/2" OW: 1" P: 3/4" D: 5/8" BL: 1" BW: 1/4"



Rebecca Knob

STAINLESS STEEL NICKEL

OD: 3/4" P: 1 1/8" BD: 3/8"



August Knob

SATIN NICKEL

OD: 1 1/8" P: 1" BD: 1/2"



Seagrove Knob

SATIN NICKEL

OL: 1 3/8" OW: 1" P: 1 1/2" BD: 1/2"



Bristol Knob

BRUSHED NICKEL

OS: 1 1/4" P: 1 1/8" BS: 1/2"

- OD Overall Diameter
- OL Overall Length
- OW Overall Width
- OS Overall Square
- P Projection
- BD Base Diameter
- BL Base Length
- BW Base Width
- BS Base Square

 = 1/4 Inch

OLD BISCAYNE DESIGNS

Hardware



Lisette Small Knob

ANTIQUe BRASS & ANTIQUe SILVER

OD:1" P: 1" BD: 1/2"



Lisette Knob

ANTIQUe BRASS & ANTIQUe SILVER

OD:1 1/4" P: 1" BD: 3/4"



Laurel Knob

ANTIQUe BRASS & ANTIQUe PEWTER

OD: 1 1/8" P: 1" BD: 5/8"

Phyllis 9" Pull

SILVER

OL: 8 3/4"

OW: 3/4"

P: 1 3/8"

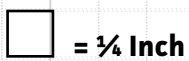

OD Overall Diameter
OL Overall Length
OW Overall Width
P Projection
BD Base Diameter

Belgium Pull

CHROME & POLISHED BRASS

OL: 5 1/2" OW 4 1/4" P: 1 1/4"

BL: 2 1/2" BW: 1"



OL Overall Length
OW Overall Width
P Projection
BL Base Length
BW Base Width

 = 1/4 Inch

Rev. 071421

20

1/2 1 1/2 2 3/2 4 5/2 6 7/2 8

Leatrice False Key

ANTIQUÉ BRASS

OL: 10" OW: 1" P: 1 1/2"



Walsh Knob

ANTIQUÉ BRASS

OS: 1 1/4" P: 1" BS: 3/4"



McCardie Bull Pull

ANTIQUÉ BRASS

OL: 3" OW: 1 7/8" P: 1"



 = 1/4 Inch

OL Overall Length
OW Overall Width
P Projection
BS Base Square

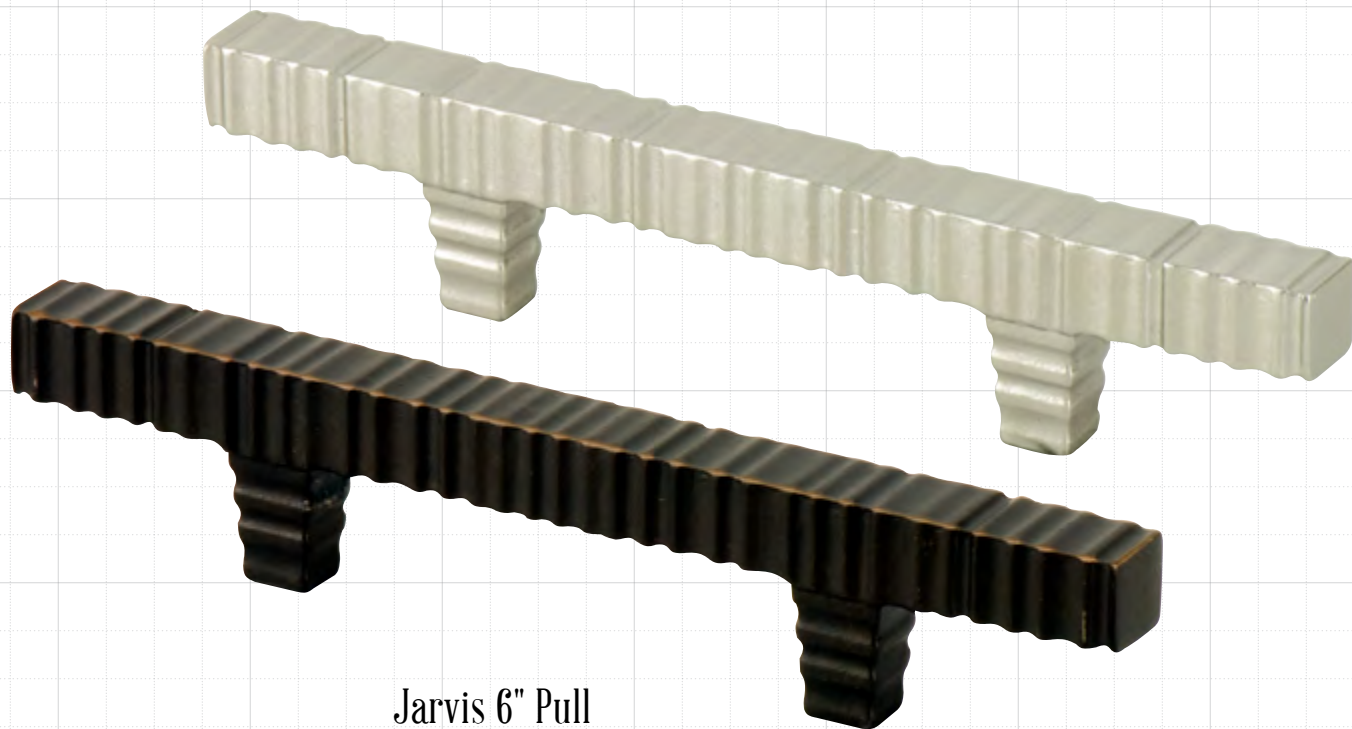

Jarvis 6" Pull

SATIN NICKEL & OIL RUBBED BRONZE

OL: 6" OW: 1/2" P: 1 1/8" BS: 3/8" CC: 3"



Meghan 2" Knob

SATIN NICKEL & OIL RUBBED BRONZE

OL: 2" OW: 2" P: 1" BS: 1/2"

OL Overall Length
 OW Overall Width
 P Projection
 BS Base Square
 CC Center to Center

 = 1/4 Inch

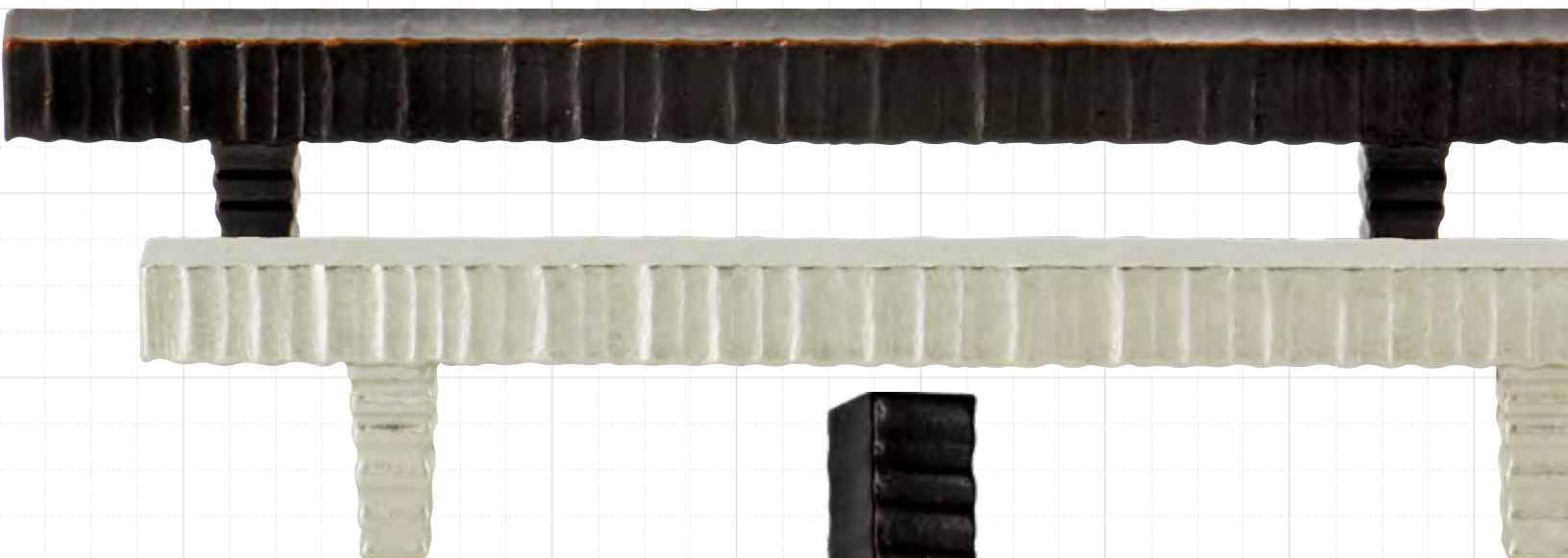

Jarvis 9" Pull

AVAILABLE IN SATIN NICKEL
& OIL RUBBED BRONZE

OL: 9" OW: 5/8" P: 1 3/4" BS: 1/2" CC: 6 1/4"

Jarvis 17" Pull

AVAILABLE IN SATIN NICKEL
& OIL RUBBED BRONZE

OL: 17" OW: 5/8" P: 1 3/4" BS: 1/2" CC: 14 1/2"



= 1/4 Inch

OL Overall Length
OW Overall Width
P Projection
BS Base Square
CC Center to Center



Havana Knob

POLISHED CHROME & MATTE BLACK

OL: 1 3/8" OW: 7/8" P: 7/8" OL: 1/2" OW: 3/8"



Manderio Pull

CHROME

OW: 2 1/4" P: 1 1/4" BD: 1/4" CC: 1 1/4"



Havana 6" Pull

POLISHED CHROME & MATTE BLACK

OL: 5 3/8" OW: 1 1/4" P: 1" OL: 1/2" OW: 3/8" CC: 3 1/2"

OL Overall Length
 OW Overall Width
 P Projection
 BL Base Length
 BW Base Width
 CC Center to Center

 = 1/4 Inch



Greco Pull

CHROME & POLISHED BRASS

OL: 3 1/2" OW: 1 1/2" P: 1"

BS: 3/8" CC: 3 1/8"

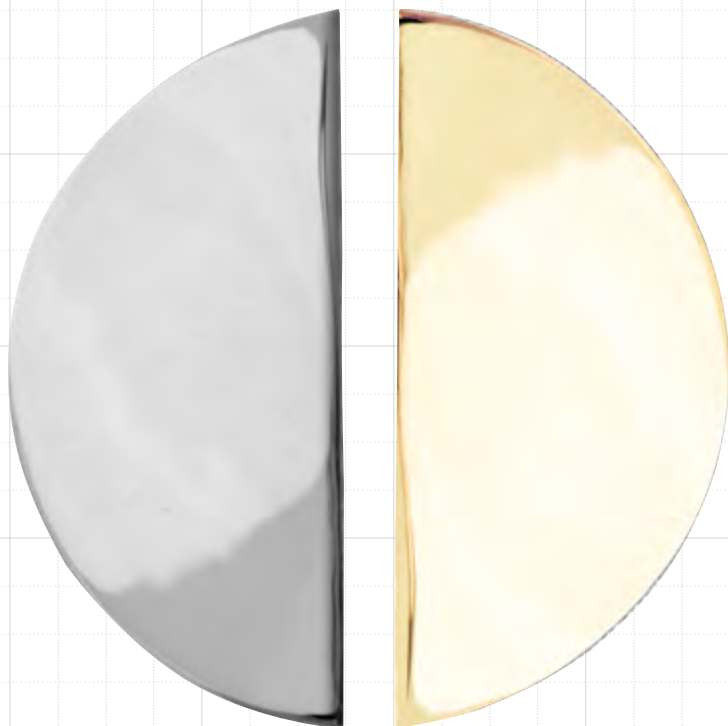
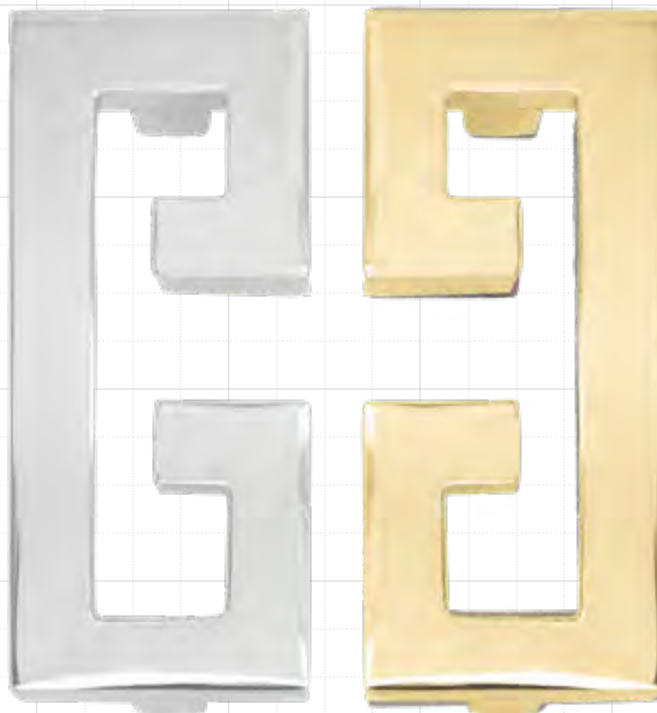

Alexas Pull

CHROME & POLISHED BRASS

OL: 3 3/4" OW: 3 3/4" P: 1 1/4"

BD: 1/2" CC: 2 1/4"

 = 1/4 Inch

OL Overall Length
OW Overall Width
P Projection
BD Base Diameter
BS Base Square
CC Center to Center

Hector Knob

MATTE BLACK & BRUSHED NICKEL

OL: 2" OW: 1/2" P: 1 1/2" BD: 1/2"



Hector 7" Pull

MATTE BLACK & BRUSHED NICKEL

OL: 7" OW: 1/2" P: 1 1/2" BD: 1/2" CC: 5"



Hector 11" Pull

MATTE BLACK & BRUSHED NICKEL

OL: 11" OW: 1/2" P: 1 1/2" BD: 1/2" CC: 8 3/4"

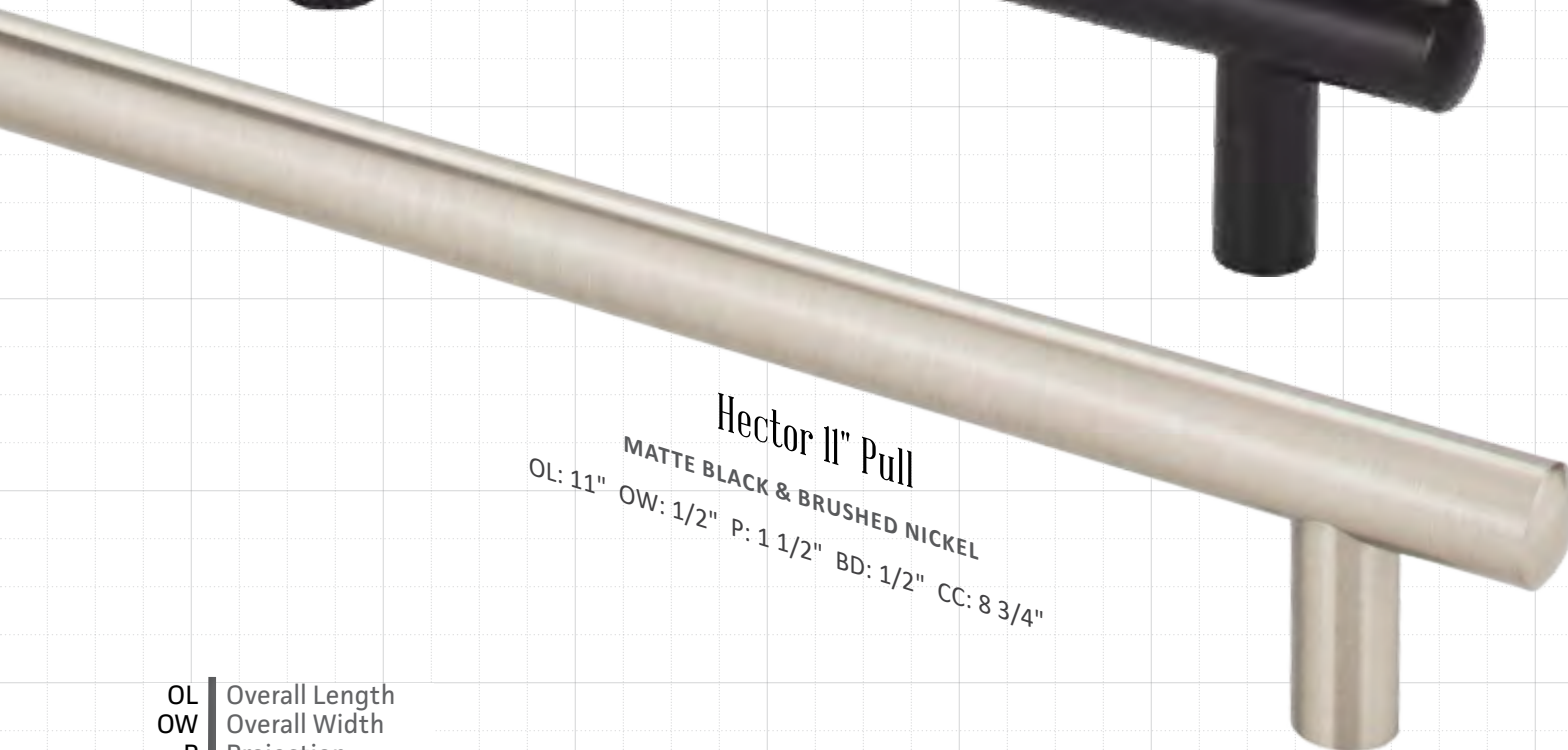

OL Overall Length
 OW Overall Width
 P Projection
 BD Base Diameter
 CC Center to Center

 = 1/4 Inch



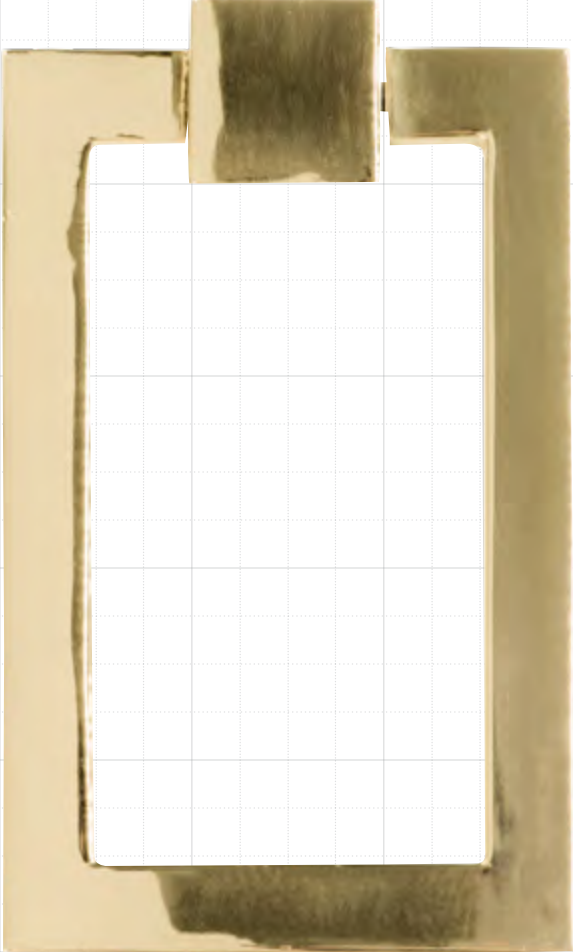

Collins Drop Pull

POLISHED BRASS

OL: 5" OW: 3" P: 1 1/4" BL: 1" BW: 1"

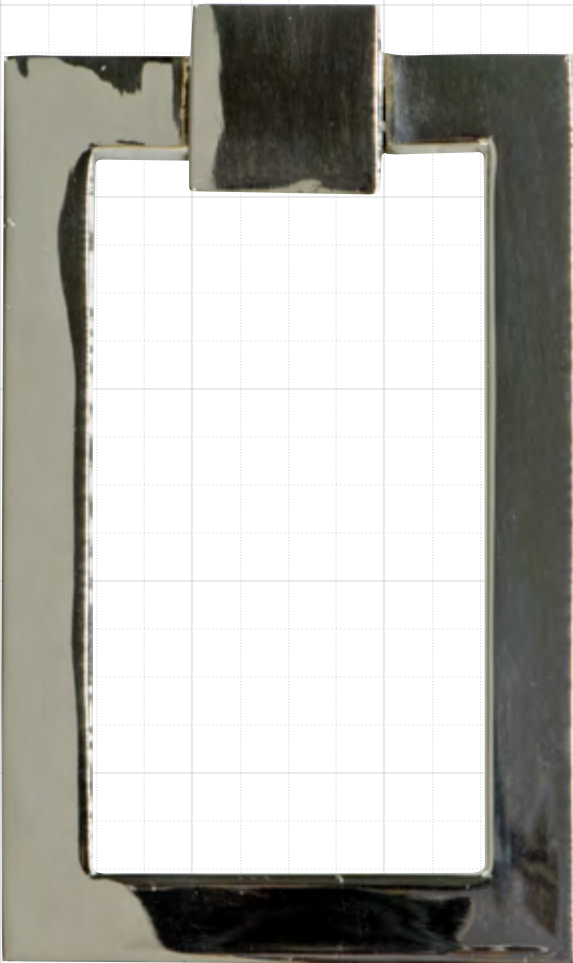

Collins Drop Pull

POLISHED NICKEL

OL: 5" OW: 3" P: 1 1/4" BL: 1" BW: 1"

OL Overall Length
OW Overall Width
P Projection
BL Base Length
BW Base Width

 = 1/4 Inch



Christolfe Small Knob

SATIN NICKEL & OIL RUBBED BRONZE

OS: 7/8" P: 7/8" BS: 5/8"



Christolfe Knob

SATIN NICKEL & OIL RUBBED BRONZE

OS: 1" P: 3/4" BS: 1/2"



Christolfe 3" Pull

SATIN NICKEL & OIL RUBBED BRONZE

OL: 3" OW: 3/4" P: 1" BS: 3/8" CC: 1 7/8"



Christolfe 6" Pull

SATIN NICKEL & OIL RUBBED BRONZE

OL: 5 7/8" OW: 3/4" P: 1" BS: 3/8" CC: 3"

Christolfe 9" Pull

SATIN NICKEL & OIL RUBBED BRONZE

W: 8 5/8" OW: 3/4" P: 1" BS: 3/8" CC: 6"



OL Overall Length
 OW Overall Width
 P Projection
 BS Base Square
 CC Center to Center

 = 1/4 Inch



Navarre Knob

ANTIQUÉ BRASS, ANTIQUÉ PEWTER, & SATIN NICKEL

OD: 1 1/4" P: 1" BD: 1/2"

Navarre Ring

ANTIQUÉ BRASS, ANTIQUÉ PEWTER, &
SATIN NICKEL

OL: 2" OW: 1 7/8" P: 3/4" BD: 1 7/8"



Navarre Pull

ANTIQUÉ BRASS, ANTIQUÉ PEWTER,
& SATIN NICKEL

OL: 4 3/8" OW: 1/2" P: 1 1/8"

BL: 1/2" BW: 3/8" CC: 3 3/4"



OL Overall Length
OW Overall Width
OD Overall Diameter
P Projection
BL Base Length
BW Base Width
BD Base Diameter
CC Center to Center

 = 1/4 Inch

OLD BISCAYNE DESIGNS



Aston Knob

SATIN NICKEL & OIL RUBBED BRONZE

OD: 1 1/2" P: 1 1/8" BD:1/2"

Aston 9" Pull

AVAILABLE IN SATIN NICKEL & OIL RUBBED BRONZE

OL: 9" OW: 1" P: 1 1/8" BS: 1/2" CC: 6"

OL Overall Length
OW Overall Width
OD Overall Diameter
P Projection
BS Base Square
BD Base Diameter
CC Center to Center

 = 1/4 Inch

30

Rev. 121719

1/2 1 1/2 2 3 4 5 6 7 8

OLD BISCAYNE DESIGNS

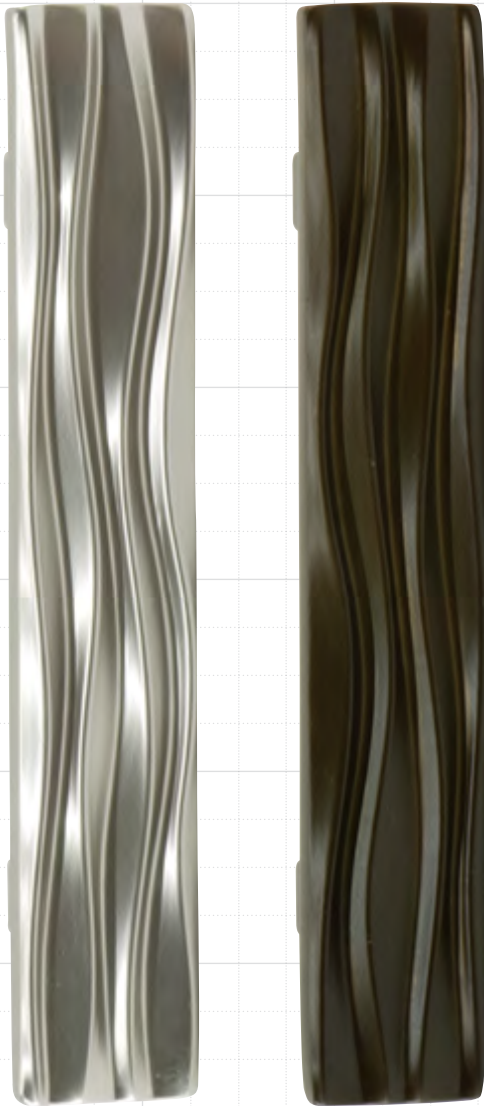

Aston 6" Pull

SATIN NICKEL & OIL RUBBED BRONZE

OL: 5 3/4" OW: 1" P: 1 1/8" BS: 1/2" CC: 3 3/4"

Aston 17" Pull

AVAILABLE IN SATIN NICKEL
& OIL RUBBED BRONZE

OL: 17" OW: 1 1/2" P: 1 1/8"
BS: 5/8" CC: 14 1/2"

OL Overall Length
OW Overall Width
P Projection
BS Base Square
CC Center to Center

 = 1/4 Inch

Rev. 121719

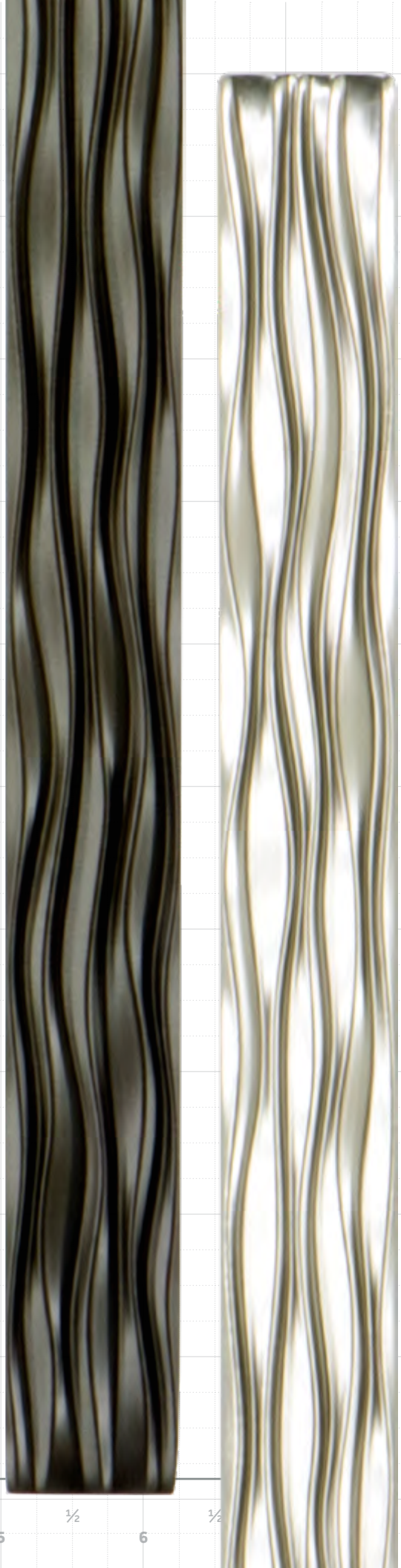

OLD BISCAYNE DESIGNS



Monique 15" Door Pulls

ANTIQUE BRONZE
& ANTIQUE SILVER

OL: 14 5/8" OW: 1 1/4"

P: 2 1/4" CC: 9 1/4"



OL Overall Length
OW Overall Width
P Projection
CC Center to Center

 = 1/4 Inch

OLD BISCAYNE DESIGNS

Hardware

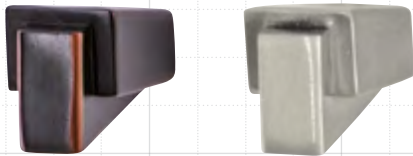

Arlie Knob

OIL RUBBED BRONZE
& SATIN NICKEL

OL: 3/4" OW: 5/8" P: 1 1/4"

BL: 3/8" BW: 5/8"

OL Overall Length
OW Overall Width
P Projection
BS Base Square
BD Base Diameter
CC Center to Center



Arlie 4" Pull

OIL RUBBED BRONZE
& SATIN NICKEL

OL: 4 3/8" OW: 3/4" P: 1 1/4"

BL: 3/8" BW: 3/4" CC: 3 3/4"



Arlie 13" Pull OIL RUBBED BRONZE & SATIN NICKEL

OL: 13 1/4" OW: 1" P: 1 3/4" BL: 3/4" BW: 1" CC: 12"

 = 1/4 Inch

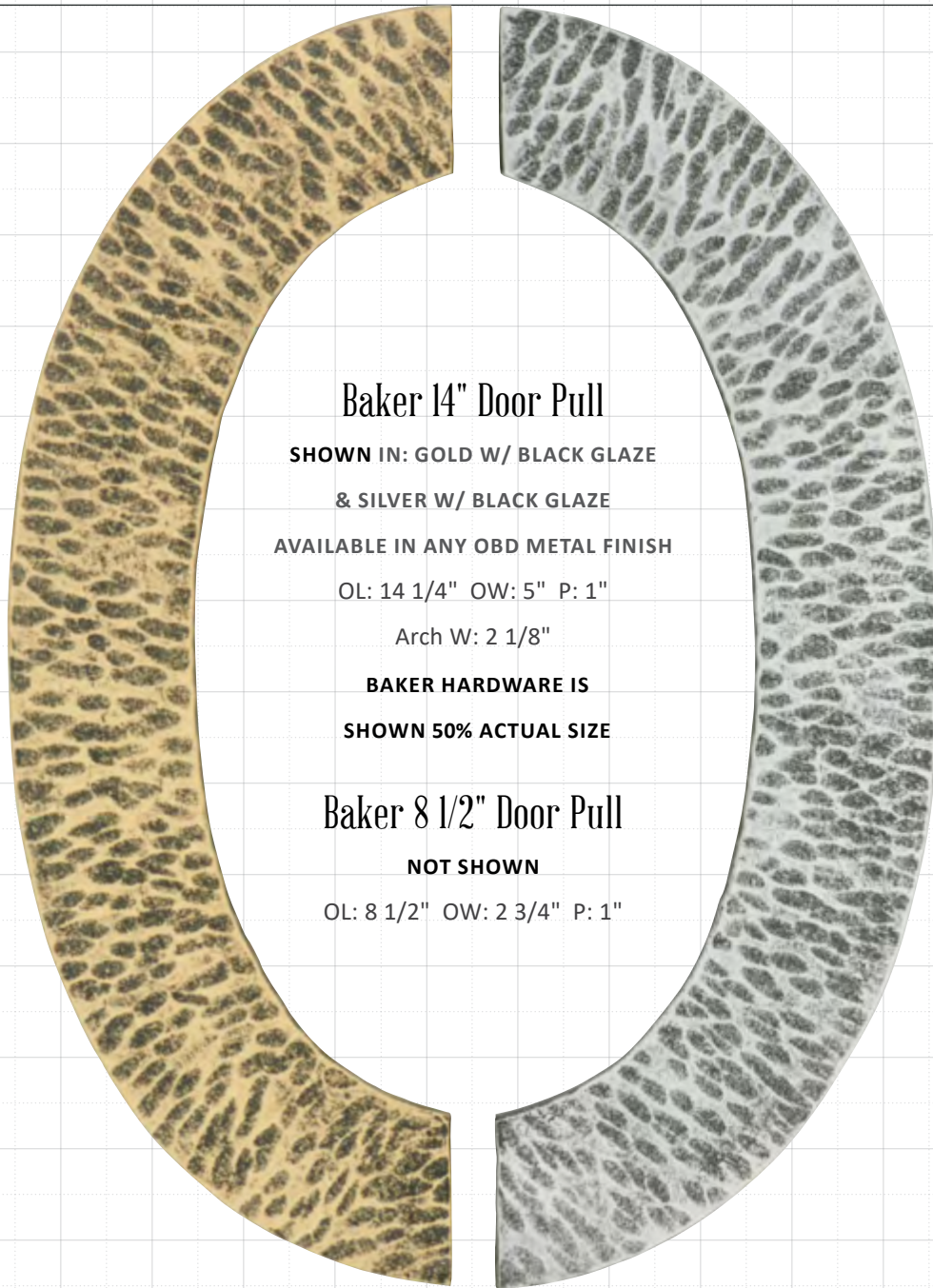

Baker 14" Door Pull

SHOWN IN: GOLD W/ BLACK GLAZE

& SILVER W/ BLACK GLAZE

AVAILABLE IN ANY OBD METAL FINISH

OL: 14 1/4" OW: 5" P: 1"

Arch W: 2 1/8"

BAKER HARDWARE IS

SHOWN 50% ACTUAL SIZE

Baker 8 1/2" Door Pull

NOT SHOWN

OL: 8 1/2" OW: 2 3/4" P: 1"

Baker knob

GOLD W/ BLACK GLAZE & SILVER W/ BLACK GLAZE

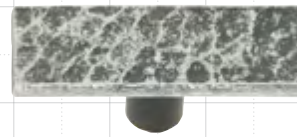

AVAILABLE IN ANY OBD METAL FINISH

OL: 3" OW: 1" P: 1"

= 1/2 Inch

OL | Overall Length
 OW | Overall Width
 P | Projection

OLD BISCAYNE DESIGNS

Hardware

John Kobe Small 7" Door Pull

SILVER W/ BLACK GLAZE

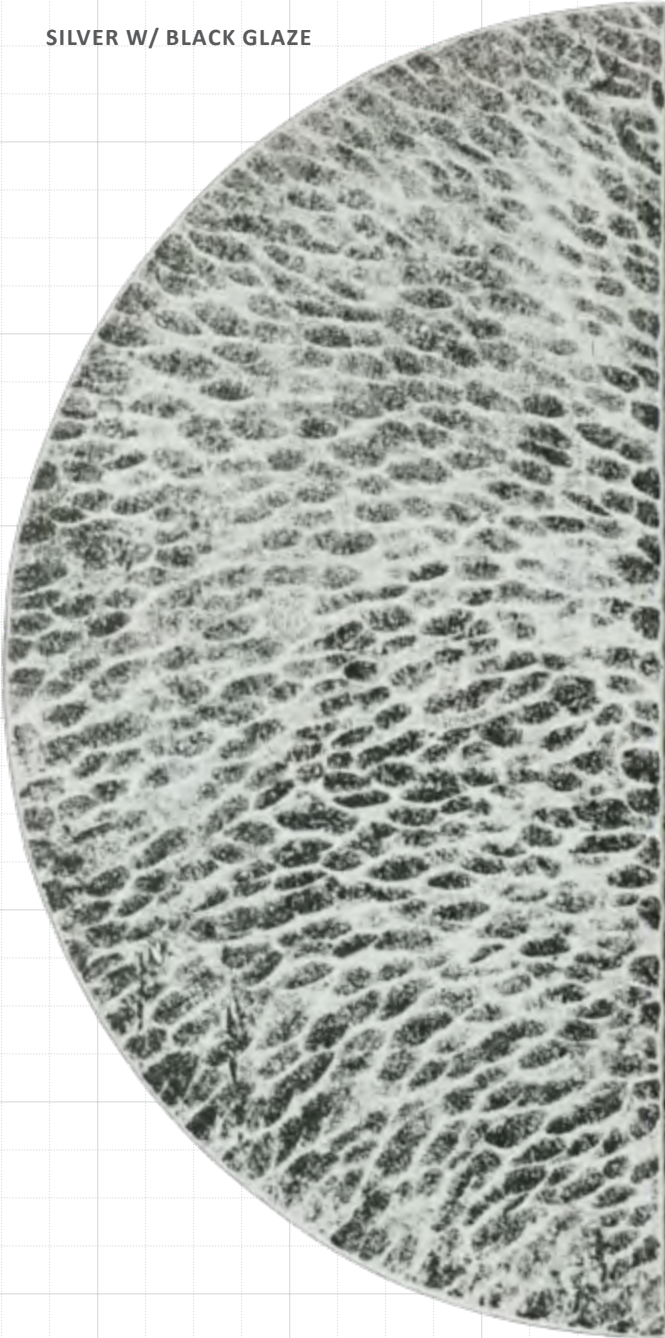

GOLD W/ BLACK GLAZE



AVAILABLE IN ANY OBD METAL FINISH

OL: 7" OW: 3 1/2" P: 1"

John Kobe 12" Door Pull

NOT SHOWN AVAILABLE IN ANY OBD METAL FINISH

OL: 11 3/4" OW: 6" P: 1"

 = 1/4 Inch

OL | Overall Length
OW | Overall Width
P | Projection



Seth Door Cranks

LONG VIEW (LEFT)

NOT TO SCALE

SHOWN IN ANTIQUE BRONZE

Fits Doors Up To 9' Tall;
May be Trimmed for Small Doors

FIRST BRACKET

W: 1 1/2" L: 3 1/8"

SECOND BRACKET

W: 1 1/2" L: 2 3/8"

THIRD BRACKET

W: 1 1/2" L: 1 5/8"

BRACKET WITH HANDLE

W: 1 3/4" L: 6"

HANDLE

W: 1 3/8" L: 3" P: 1 7/8"

AVAILABLE IN:

Antique Bronze Flower Pattern,
Antique Bronze Diamond Pattern,
& Antique Silver Diamond Pattern



ANTIQUÉ BRONZE FLOWER

L | Length
W | Width
P | Projection

= 1/4 Inch

OLD BISCAVNE DESIGNS

Hardware



ANTIQUE BRONZE DIAMOND

ANTIQUE SILVER DIAMOND

= ¼ Inch



Pablo Pull

SHOWN IN: CHROME

& POLISHED BRASS

AVAILABLE IN ANY

OBD METAL FINISH

OL: 6" OW: 2 1/2" P: 1 3/8"

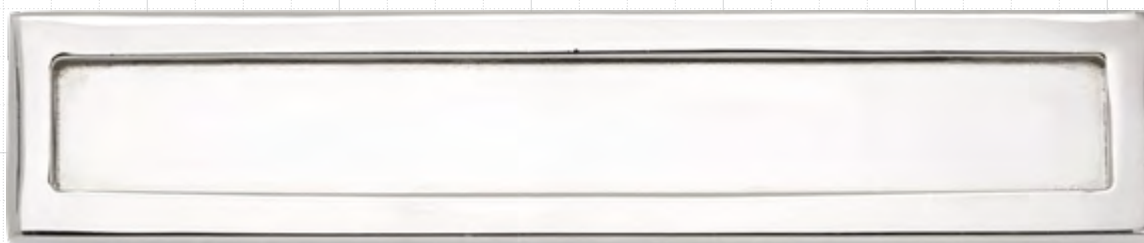

Pablo Bar

SHOWN IN: CHROME AVAILABLE IN ANY OBD METAL FINISH

OL: 6" OW: 1 1/4" P: 1 3/8"

OL	Overall Length
OW	Overall Width
P	Projection

 = 1/4 Inch





Sibony Pull

CHROME

OL: 6 1/2" OW: 5" P: 2 1/4"

= 1/4 Inch

OL | Overall Length
OW | Overall Width
P | Projection

OLD BISCAYNE DESIGNS

OL Overall Length
OW Overall Width
P Projection

Harpur Pull

POLISHED BRASS & CHROME

OL: 18" OW: 2 1/4" P: 1 1/4"

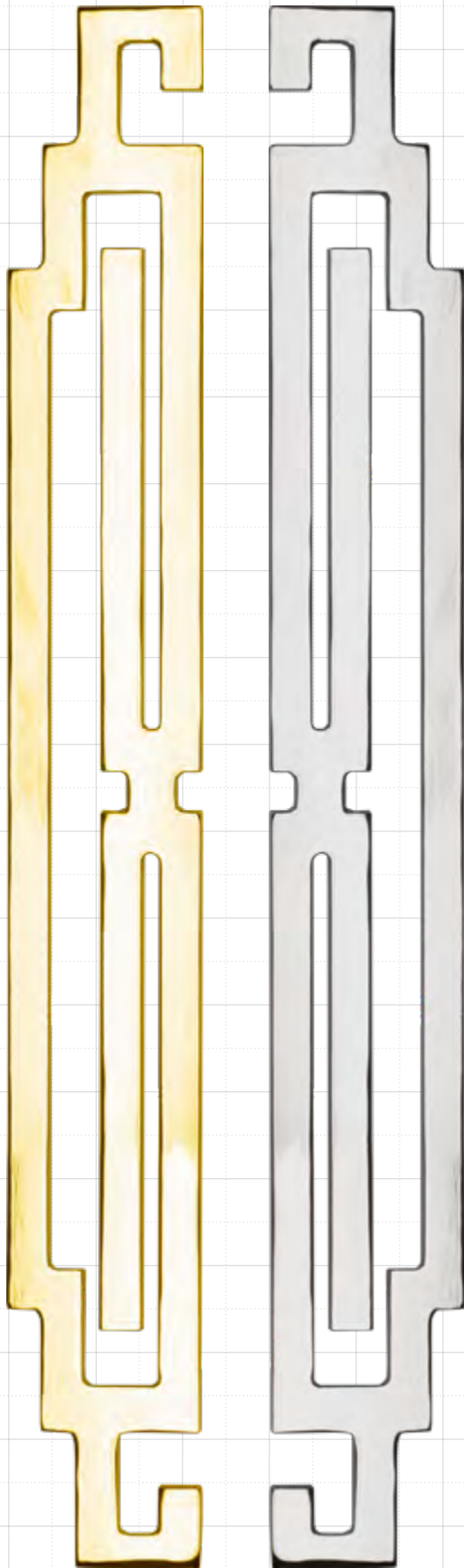

PICTURED IN ACTUAL SIZE

 = 1/2 Inch

40

121719

1/2 1 2 3 4 5 6 7 8 9 10 11 12 13 14 15 16

OLD BISCAYNE DESIGNS

PICTURED IN ACTUAL SIZE

Laurent Pull

WALNUT

OL: 22" OW: 4" P: 1"

AVAILABLE IN
ALL OBD
FINISHES

 = 1/2 Inch

OL | Overall Length
OW | Overall Width
P | Projection

1/2

1/2

5

1/2

6

1/2

7

8



Ithaca Pulls

CHROME

OL: 7" OW: 3 1/2" P: 1 1/4"

OL Overall Length
OW Overall Width
P Projection

 = 1/4 Inch

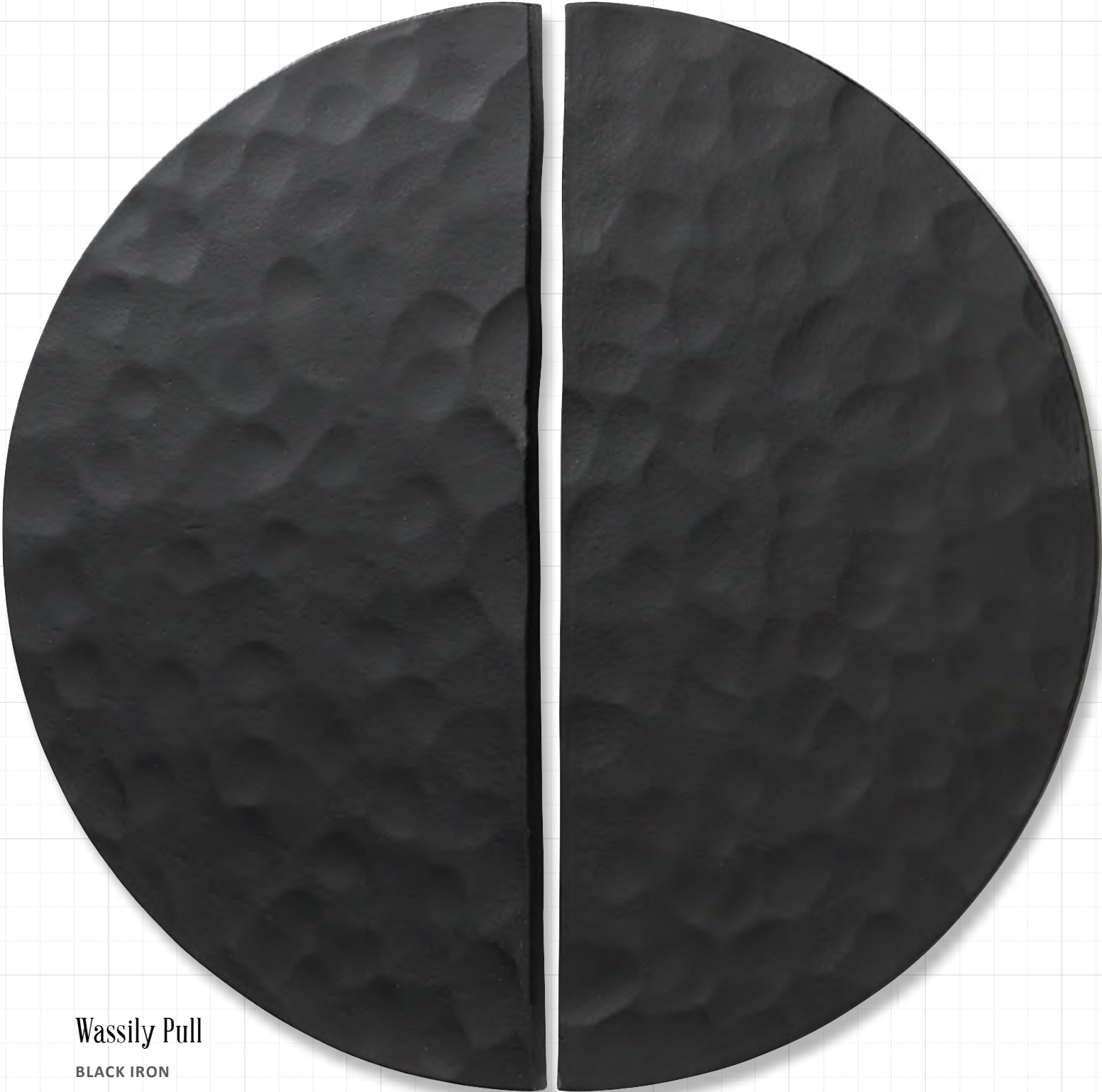

Wassily Pull

BLACK IRON

OL: 8" OW: 4" P: 1 1/4"

 = 1/4 Inch

OL | Overall Length
OW | Overall Width
P | Projection

Varo Pull

POLISHED BRASS

OL: 7" OW: 4" P: 1 1/4"

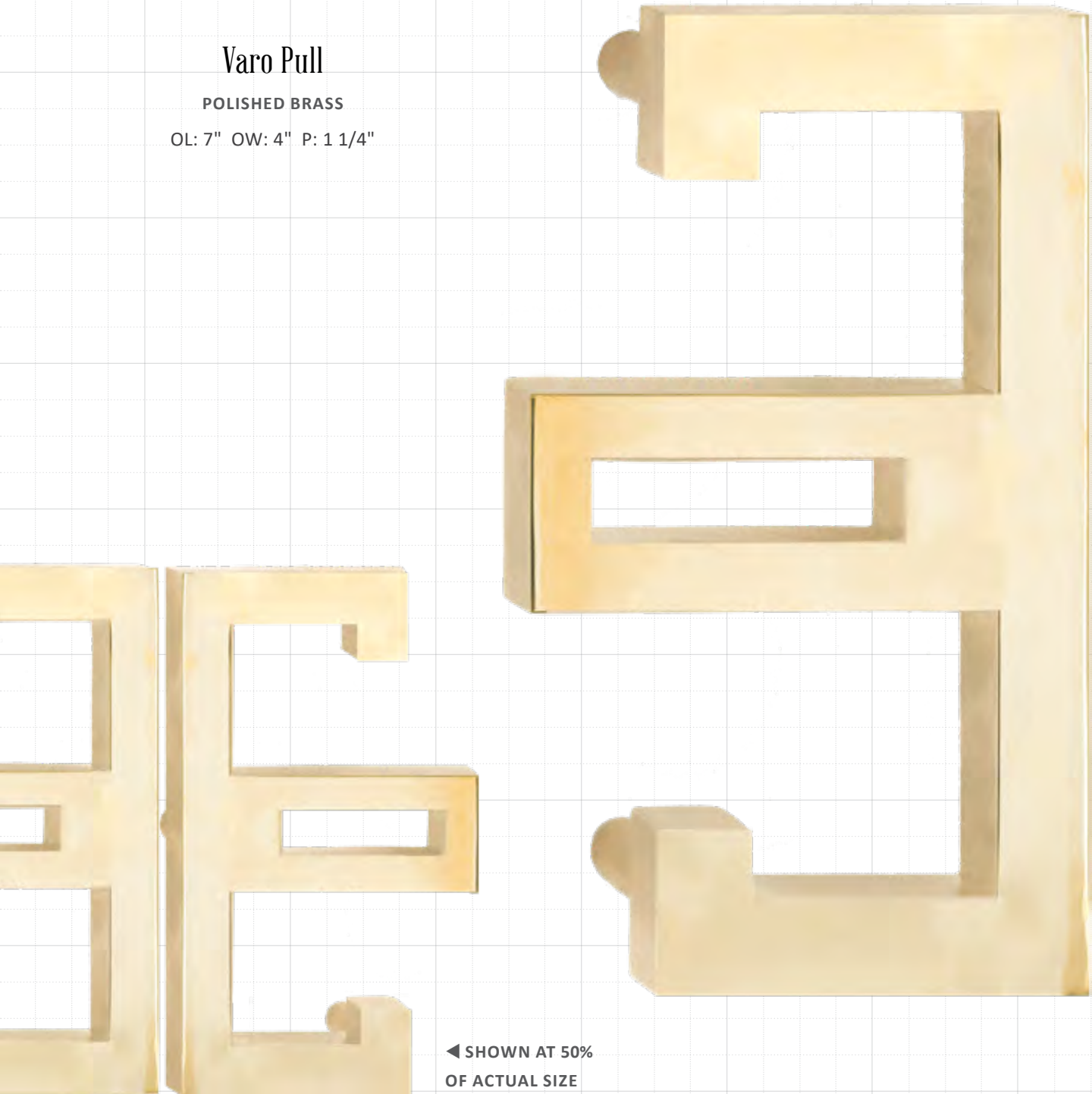

◀ SHOWN AT 50%
OF ACTUAL SIZE

 = 1/4 Inch

OL | Overall Length
OW | Overall Width
P | Projection

Beckett Pull

SHOWN IN: TAVERN EXPRESSO W/ HAND BLOWN MIRROR

AVAILABLE IN ANY OBD FINISH

OL: 5" OW: 3 1/2" P: 2"



OL Overall Length
OW Overall Width
P Projection

 = 1/2 Inch

Rev. 121719

45

Escobar Pulls & Knobs

AVAILABLE IN:

- Brushed Antique Brass,
- Brushed Brass
- Oil Rubbed Bronze
- & Satin Nickel

Escobar 9" Pull

OL: 6 1/2" OW: 3/4" P: 1 1/4"

BS: 3/8" CC: 7 1/2"

Escobar 6 1/2" Pull

OL: 6 1/2" OW: 3/4" P: 1 1/4"

BS: 3/8" CC: 5"

Escobar 4 1/2" Pull

OL: 4 1/2" OW: 3/4" P: 1 1/4"

BS: 3/8" CC: 3"

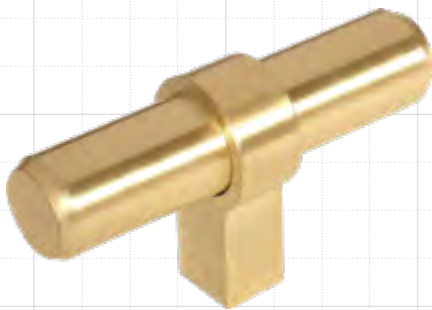

Escobar Knob

OL: 2 3/8" OW: 3/4" P: 1 1/4" BS: 3/8"

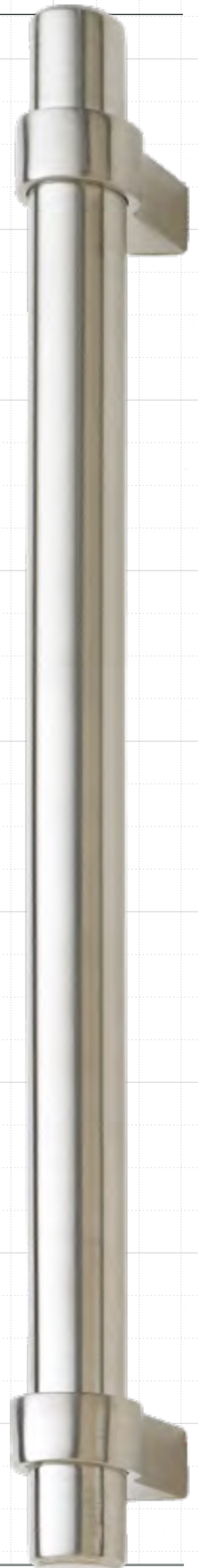

OL Overall Length
 OW Overall Width
 P Projection
 BS Base Square
 CC Center to Center

 = 1/4 Inch

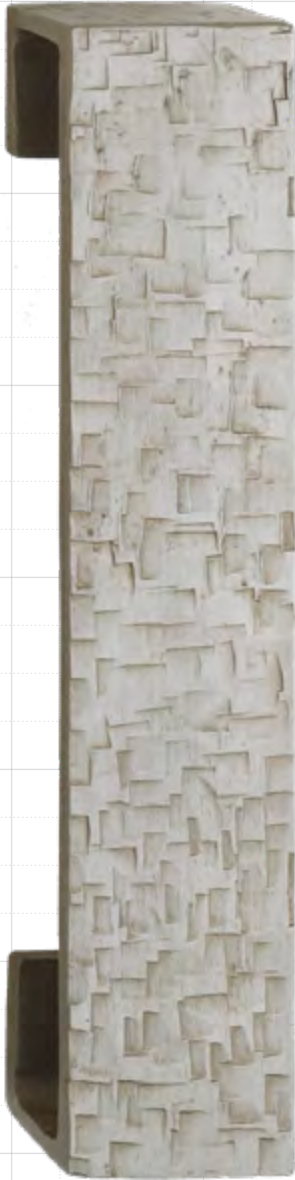

◀ SHOWN AT 50%
OF ACTUAL SIZE

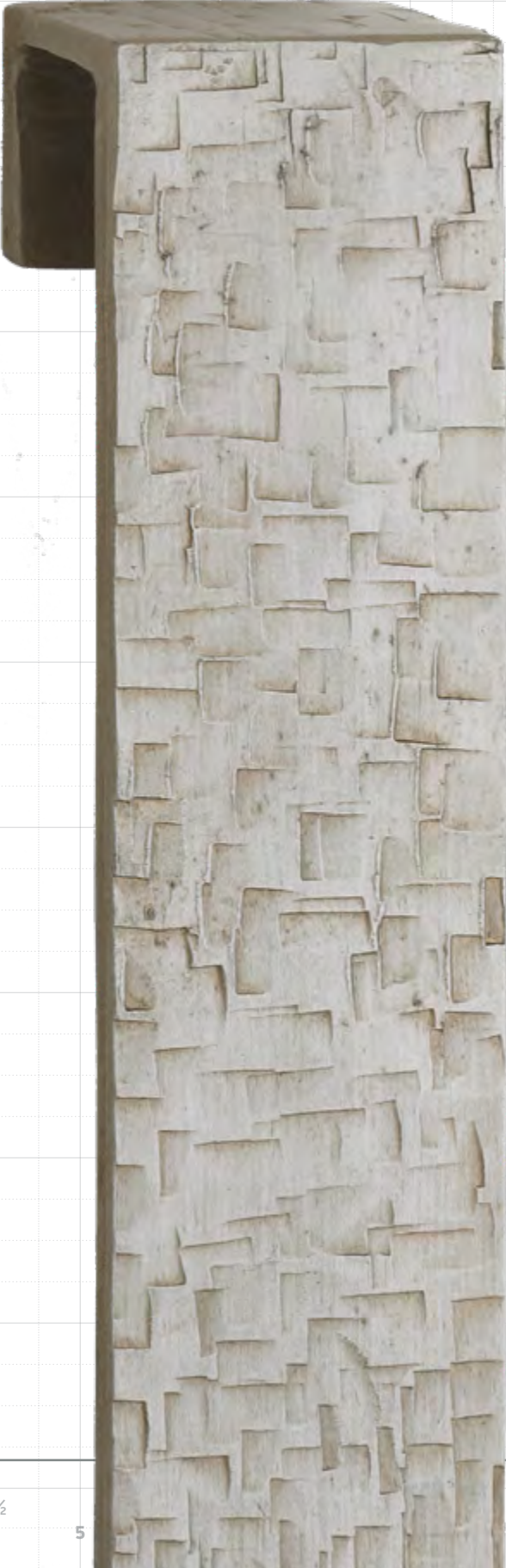

Ellis Pull

HAMMERED STEEL

OL: 12" OW: 2" P: 2"

 = ¼ Inch

OL Overall Length
OW Overall Width
P Projection

Rev. 121719

½ 1 ½ 2 ½ 3 ½ 4 ½ 5



Holden Drop Pull

BRUSHED NICKEL

BRUSHED BRASS

OIL RUBBED BRONZE

BLACK

OL: 2 1/4" OW: 2" P: 1/2" BS: 1/2"

OL	Overall Length
OW	Overall Width
P	Projection
BS	Base Square

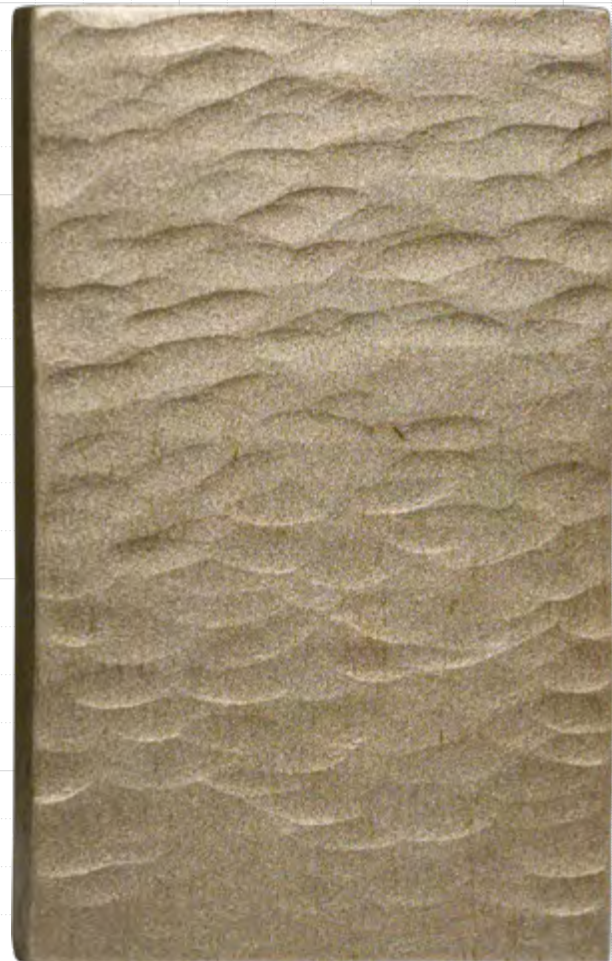

Brie Rectangle Pull

SHOWN IN: PROSECCO AVAILABLE IN ANY OBD METAL FINISH

OL: 5" OW: 3" P: 1"

 = 1/4 Inch

OLD BISCAYNE DESIGNS

Gillian Knob

SHOWN IN OIL RUBBED BRONZE

OS: 1 1/2" P: 1 1/4" BS: 1/2"



All Gillian Hardware

Available in

POLISHED CHROME

ANTIQUÉ BRONZE

BLACK MATTE

& OIL RUBBED BRONZE



Gillian Rectangle Pull

SHOWN IN ANTIQUÉ BRONZE

OL: 5" OW: 2 1/2" P: 1 3/8" BL: 1 5/8" BW: 3/8" CC: 1"

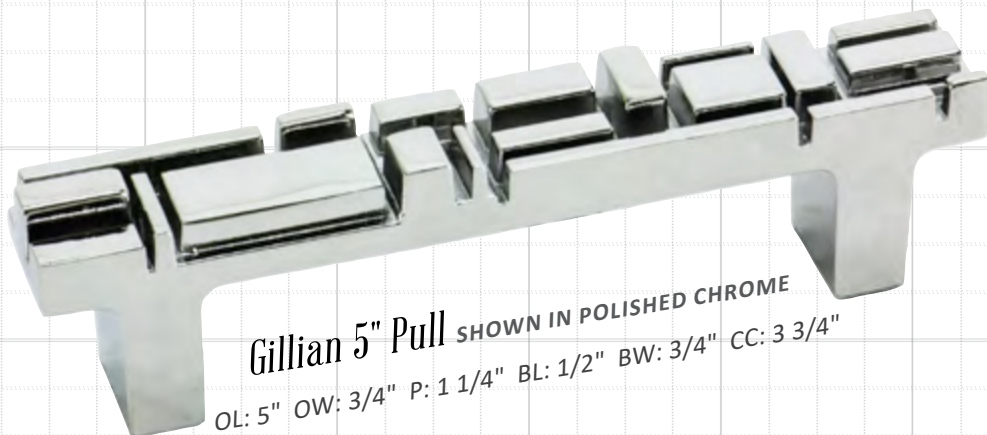

Gillian 5" Pull

SHOWN IN POLISHED CHROME

OL: 5" OW: 3/4" P: 1 1/4" BL: 1/2" BW: 3/4" CC: 3 3/4"

- OL Overall Length
- OW Overall Width
- OS Overall Square-
- P Projection
- BL Base Length
- BW Base Width
- BS Base Square
- CC Center to Center

Gillian 12" Pull

SHOWN IN BLACK MATTE

OL: 12" OW: 1" P: 1 1/2" BS: 3/8" CC: 9"

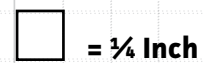

Rev. 121719

1/2 1 1/2 2 3 4 5 6 7



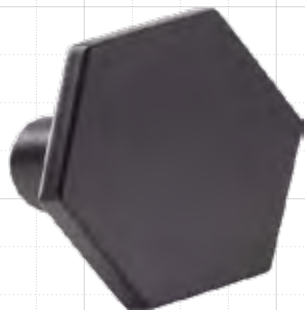

Hex Knob

OL: 1 1/2"

OW: 1 1/2"

P: 1 1/2"

Available in

MATTE BLACK

SATIN NICKEL

SATIN BRASS



Hex 8" Pull

OW: 1/2"

OL: 8"(Shown), 10", 12", & 14"

P: 1 1/2"

CC: 6"

Available in

MATTE BLACK

SATIN NICKEL

SATIN BRASS

OL Overall Length
 OW Overall Width
 P Projection
 CC Center to Center

 = 1/4 Inch



Hex Bar Knob

OW: 1/2"

OL: 1 1/2"

P: 1 1/2"

Available in

MATE BLACK

SATIN NICKEL

SATIN BRASS



Hex 6" Pull

OW: 1/2"

OL: 5", 6" (Shown) ,& 7"

P: 1 1/2"

CC: 4"

Available in

MATE BLACK

SATIN NICKEL

SATIN BRASS

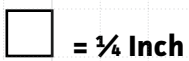

OL Overall Length
 OW Overall Width
 P Projection
 CC Center to Center

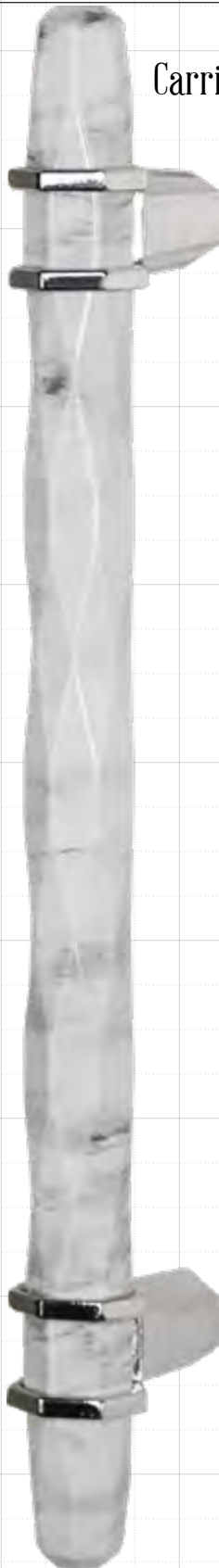

Carrione 8 3/4" Pull

OL: 8 3/4"
 OW: 3/4"
 P: 1 1/2"
 BS: 1/2"
 CC: 6 1/2"



Carrione 6 1/4" Pull

OL: 6 1/4"
 OW: 3/4"
 P: 1 1/2"
 BS: 1/2"
 CC: 3 3/4"

Carrione Hardware

Available in

- POLISHED NICKEL
- GOLDEN CHAMPAGNE
- BLACK BRONZE



Carrione Knob

OL: 2 1/2"
 OW: 3/4"
 P: 1 1/2"
 BS: 1/2"

 = 1/4 Inch

OLD BISCAVNE DESIGNS

Hardware

Diamond Back Hardware

Available in

BRUSHED NICKEL

BRUSHED BRASS

MATTE BLACK

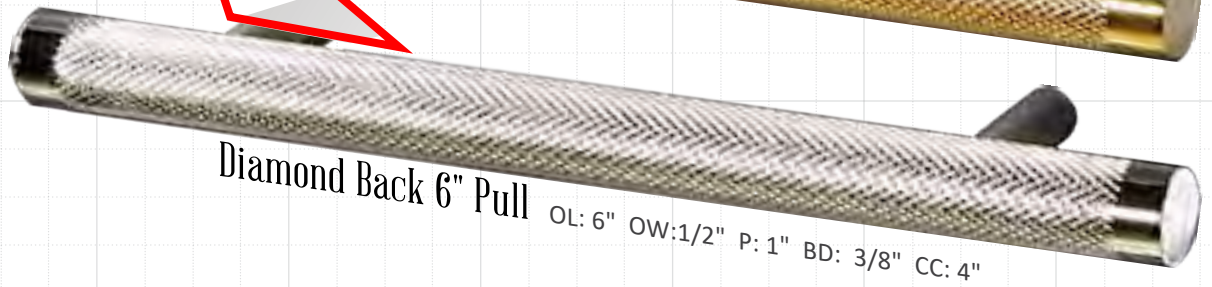
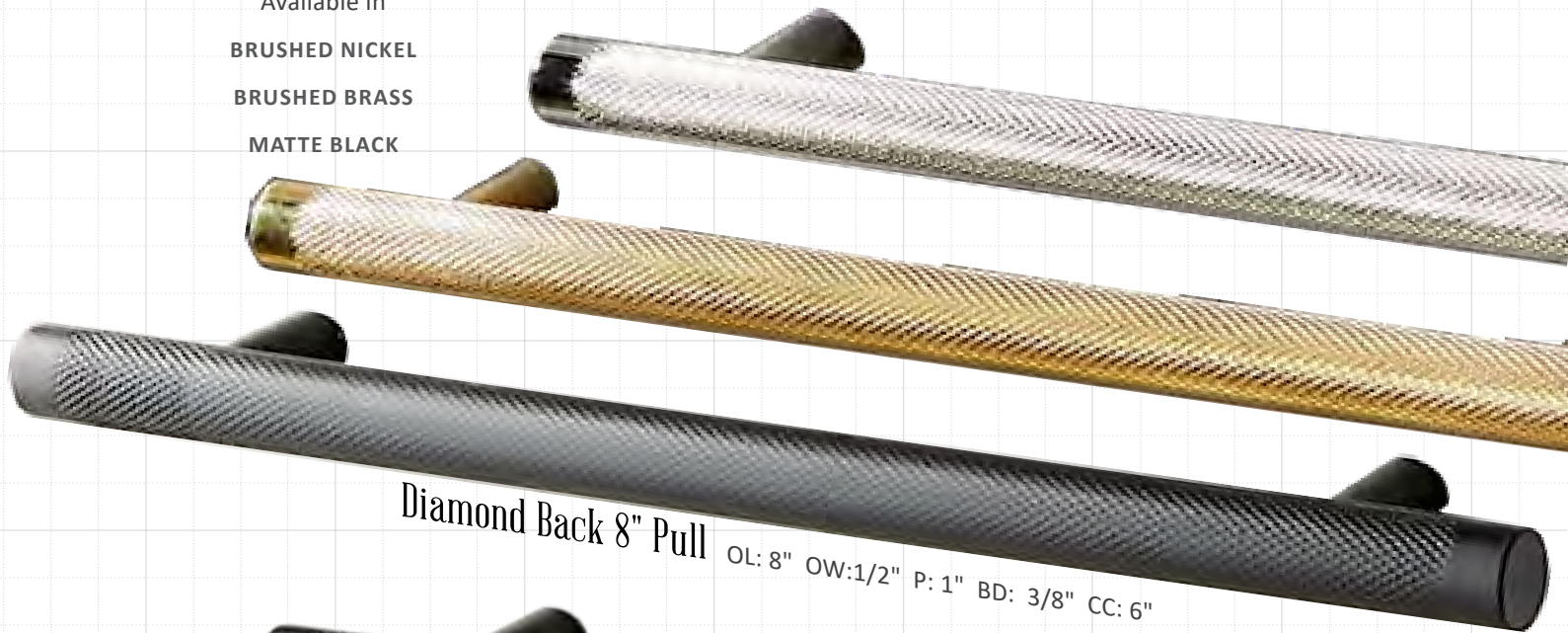

Diamond Back Knob OD: 1" P: 1"

= 1/4 Inch

OL Overall Length
OW Overall Width
OD Overall Diameter
P Projection
BD Base Diameter
CC Center to Center

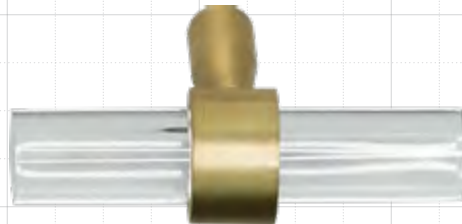

Acrylic Knob

OL: 2 1/2" OW: 3/4" P: 1 1/2" BD: 3/8"

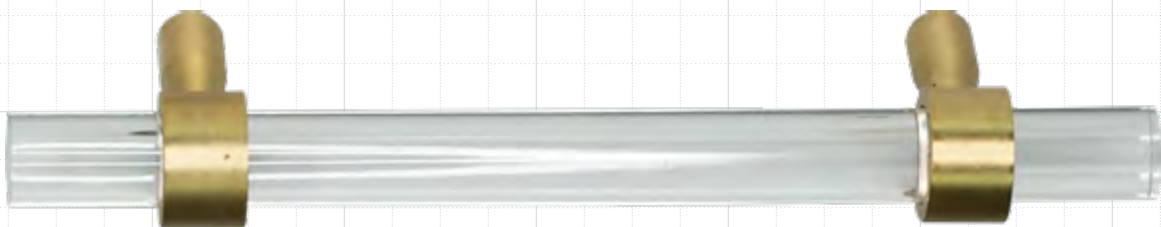

Acrylic 6" Pull

OL: 6" OW: 3/4" P: 1 1/2" BD: 3/8" CC: 4"



Acrylic 8" Pull

OL: 8" OW: 3/4" P: 1 1/2" BD: 3/8" CC: 6"

OL Overall Length
OW Overall Width
P Projection
BD Base Diameter
CC Center to Center

OLD BISCAIYNE DESIGNS

Black Marble Knob
White Marble Knob

OD: 1"
P: 1 1/4"



DISCONTINUED
Limited Stock

Black Marble Pull &
White Marble Pull

OL: 7 1/2" | 6 1/2" | 5 1/2" | 4 1/2"

OW: 3/4"

P: 1 1/2"

BD: 1/4"

CC: 6" | 5" | 4" | 3"



Quartz Knob

OL: 2 1/4"*

OW: 1"*

P: 1 1/2"*

BD: 3/8"

*Quartz Size & Color
May Vary



DISCONTINUED

OL Overall Length
OW Overall Width
P Projection
BD Base Diameter
CC Center to Center

☐ = 1/4 Inch

Rev. 121719

55



Elder Pulls

SHOWN IN: GREYSCAPE W/ ANTIQUE MIRROR

AVAILABLE IN ANY OBD FINISH & MIRROR OPTIONS

OL: 7 1/4" OW: 3 1/2" P: 1 3/4"

 = 3/4 Inch

OL | Overall Length
OW | Overall Width
P | Projection

Menlo Hardware

- Available in:
- POLISHED CHROME
 - ANCIENT BRONZE
 - MATTE BLACK
 - SATIN BRASS
 - BRUSHED NICKEL

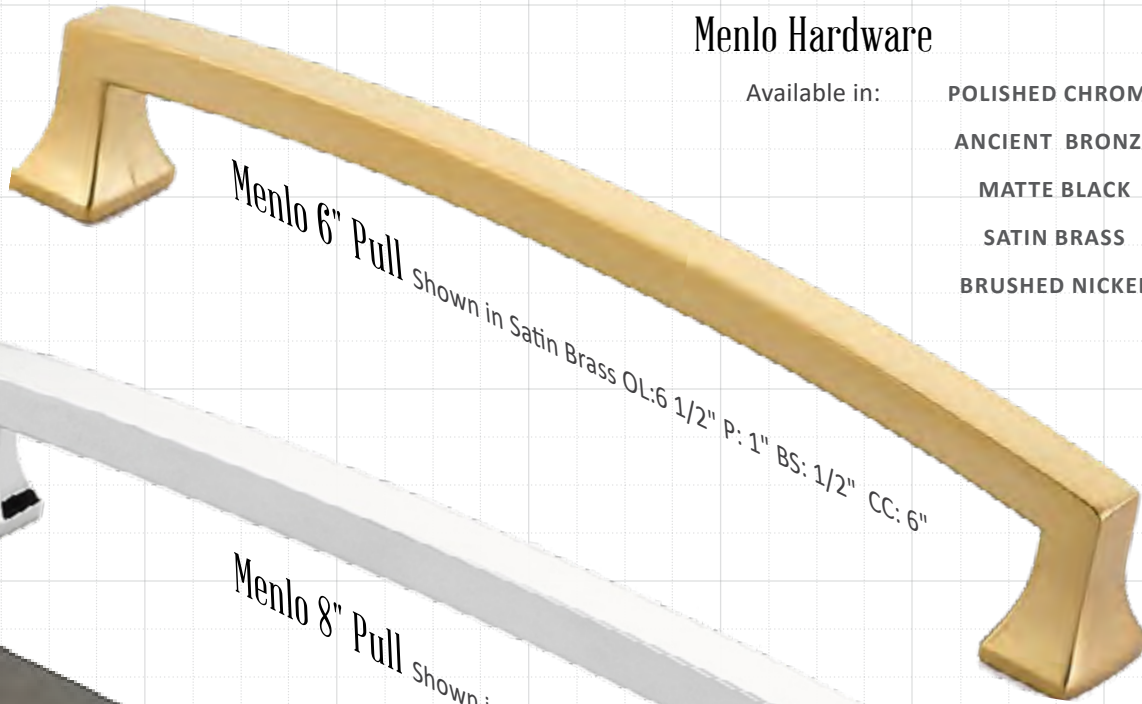

Menlo 6" Pull Shown in Satin Brass OL:6 1/2" P: 1" BS: 1/2" CC: 6"

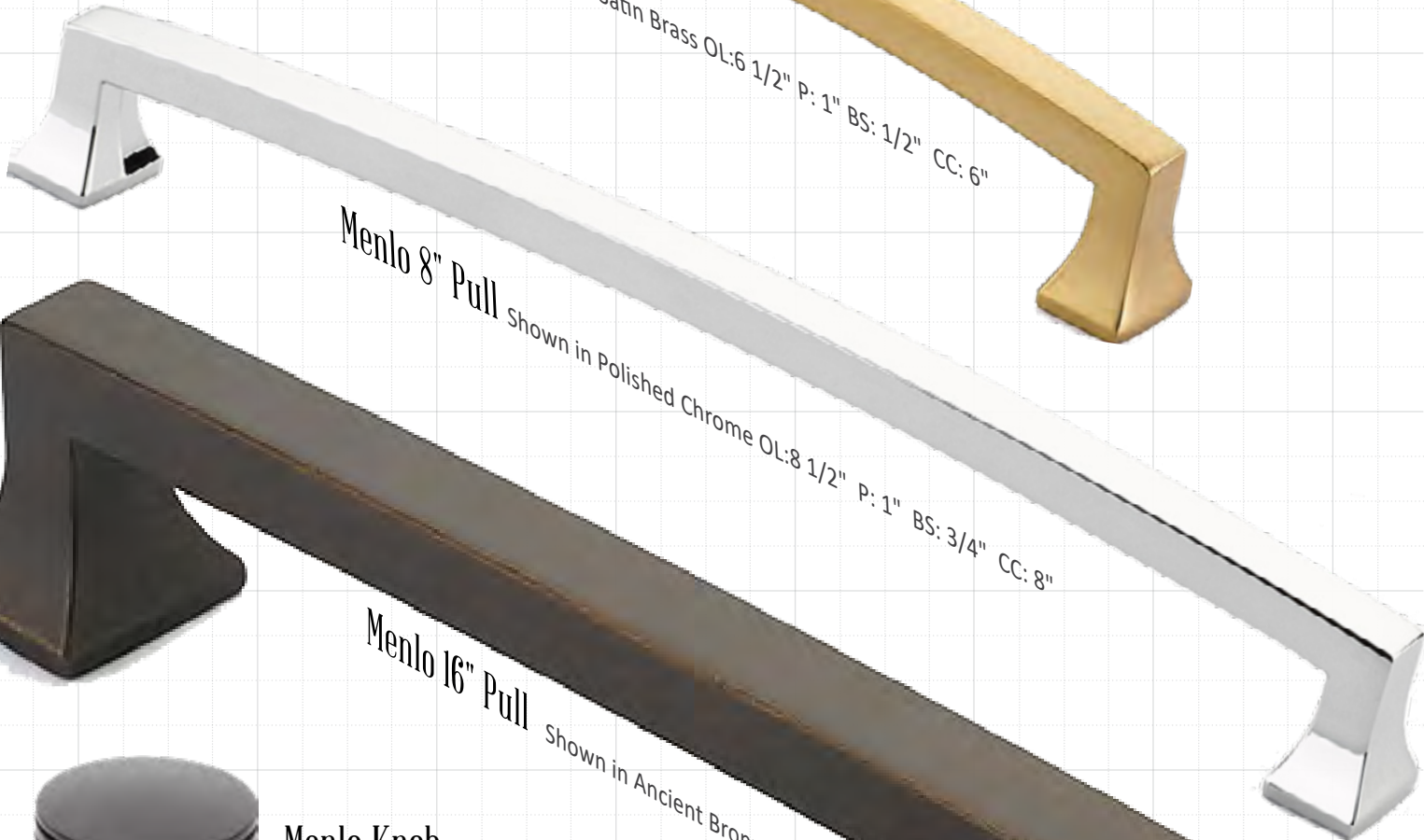

Menlo 8" Pull Shown in Polished Chrome OL:8 1/2" P: 1" BS: 3/4" CC: 8"

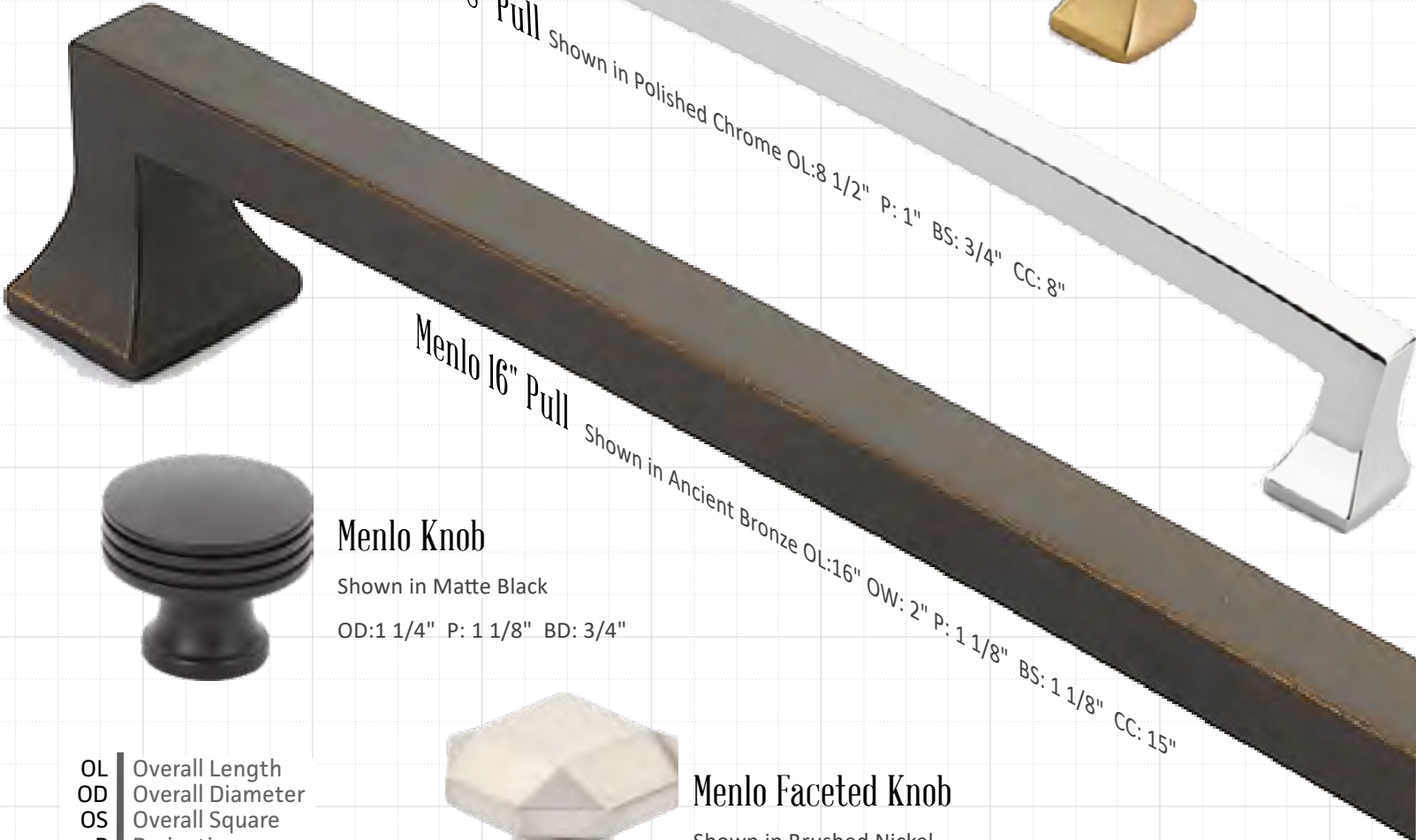

Menlo 16" Pull Shown in Ancient Bronze OL:16" OW: 2" P: 1 1/8" BS: 1 1/8" CC: 15"



Menlo Knob

Shown in Matte Black
 OD:1 1/4" P: 1 1/8" BD: 3/4"



Menlo Faceted Knob

Shown in Brushed Nickel
 OS:1 1/4" P: 1" BD: 3/4"

 = 3/4 Inch

- OL Overall Length
- OD Overall Diameter
- OS Overall Square
- P Projection
- BD Base Diameter
- BS Base Square
- CC Center to Center

OLD BISCAYNE DESIGNS

Arabi 12" & 30" Pulls

SHOWN IN: FRUTWOOD

AVAILABLE IN ANY OBD FINISH

OL: 12" | 30"

OW: 1"

P: 2 1/2"

SHOWN AT 25% ▶
OF ACTUAL SIZE

OL | Overall Length
OW | Overall Width
P | Projection

□ = 1/4 Inch

Rev. 121719

1/2 2 3 1/2 4 1/2 5 1/2 6 1/2 7 1/2 8



De Vicq Pulls

SHOWN IN: NEW BRONZE

AVAILABLE IN ANY OBD METAL FINISH

OL: 7" OW: 3 1/2" P: 1 1/4"

 = 1/4 Inch

OL | Overall Length
OW | Overall Width
P | Projection

OLD BISCAYNE DESIGNS



Ridley Pull SHOWN IN: NEW BRONZE

AVAILABLE IN ANY OBD METAL FINISH

OL: 10" OW: 2" P: 1"



Lottie Pull SHOWN IN: NEW BRONZE

AVAILABLE IN ANY OBD METAL FINISH

OL: 8" OW: 1" P: 1 1/4"



Agatha Pull

SHOWN IN:

NEW BRONZE

AVAILABLE IN ANY

OBD METAL FINISH

OL: 6" OW: 1" P: 1 1/4"

OL Overall Length
OW Overall Width
P Projection

 = 1/4 Inch

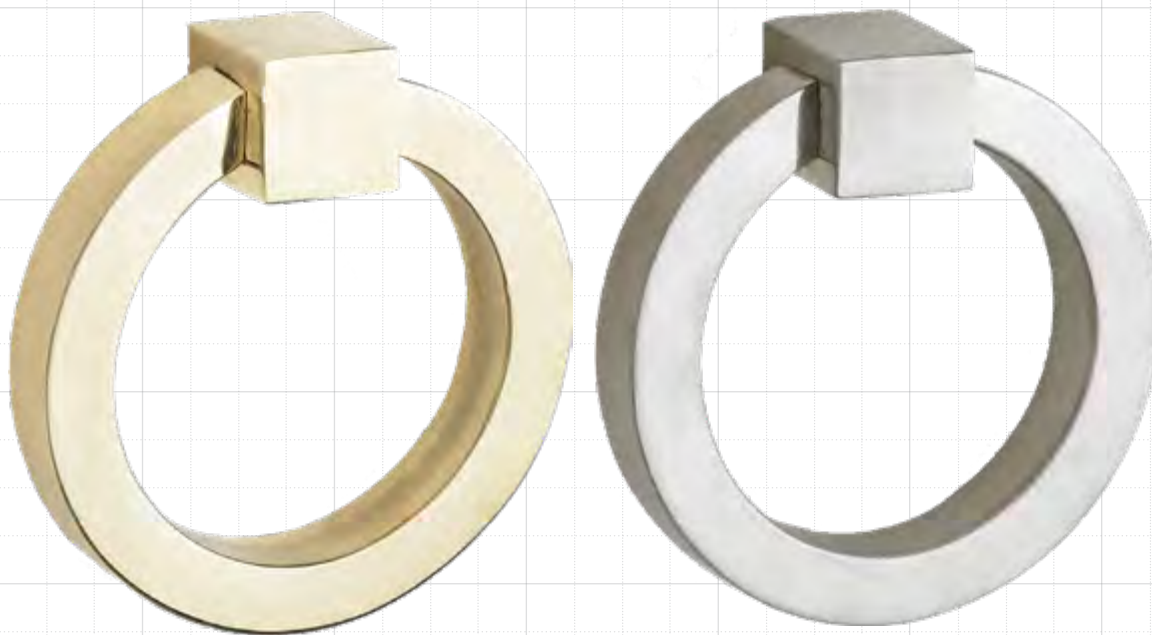

Large Holden Drop Pull

POLISHED BRASS | BRUSHED NICKEL

OL: 3 1/8" OW: 3" P: 3/4" BS: 3/4"

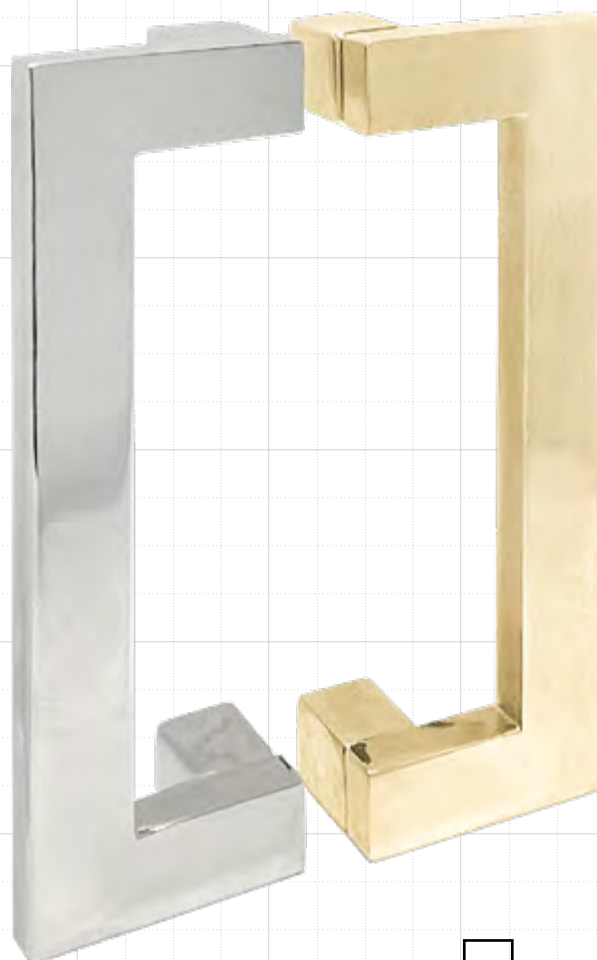

Carver Pull

POLISHED NICKEL | POLISHED BRASS

OL: 4 1/2" OW: 1 1/2" P: 3/4"

OL Overall Length
 OW Overall Width
 P Projection
 BS Base Square

Hardware Pictured in Actual Size Unless Otherwise Noted.

 = 1/4 Inch

Rev. 121719

61



Nester Pull

POLISHED NICKEL

POLISHED BRASS

OL: 7" OW: 7" P: 1"

OL Overall Length
OW Overall Width
P Projection

 = 1/4 Inch

Leonard Pull

POLISHED NICKEL

POLISHED BRASS

OL: 2 1/2" OW: 1.8" P: 3/5"



Newton Pull

POLISHED NICKEL

POLISHED BRASS

OL: 2 1/2" OW: 2 1/2" P: 1 1/4"



 = 3/4 Inch

OL | Overall Length
OW | Overall Width
P | Projection



Velasco Pull

POLISHED NICKEL

POLISHED BRASS

OL: 3 3/4" OW: 3 3/4" P: 1 1/4"



OL Overall Length
OW Overall Width
P Projection

 = 1/4 Inch



Empire Pull

POLISHED NICKEL

POLISHED BRASS

OL: 4" OW: 4" P: 1"



OL Overall Length
OW Overall Width
P Projection

 = 1/4 Inch



Voskamp Pull

POLISHED NICKEL

POLISHED BRASS

OL: 6" OW: 1 1/2" P: 1"



Raj Pull

POLISHED NICKEL

POLISHED BRASS

OL: 3 1/2" OW: 1" P: 3/4"

OL Overall Length
OW Overall Width
P Projection

 = 1/4 Inch

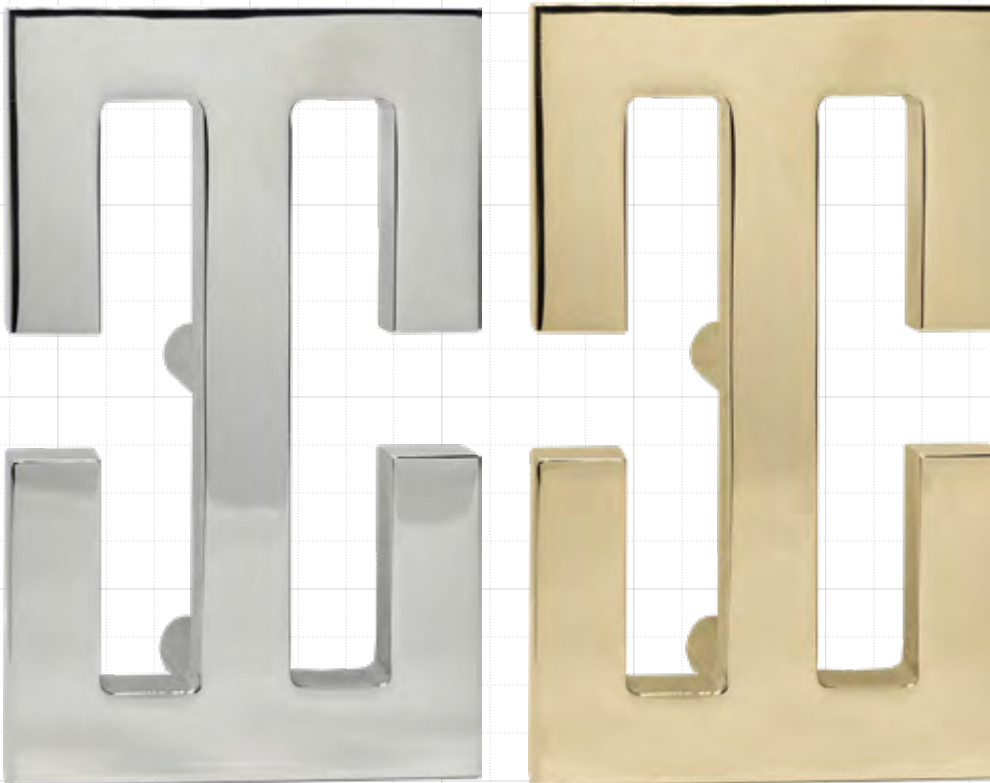

Keyser Pull

POLISHED NICKEL

POLISHED BRASS

OL: 4" OW: 2 1/2" P: 1 1/4"



Saville Pull

POLISHED NICKEL | POLISHED BRASS

OL: 1/2" OW: 6" P: 3/4"

OL | Overall Length
OW | Overall Width
P | Projection

 = 3/4 Inch



Theodora Pull

ANTIQUÉ BRASS
80509ABS

W: 5 1/2" H: 3/4"

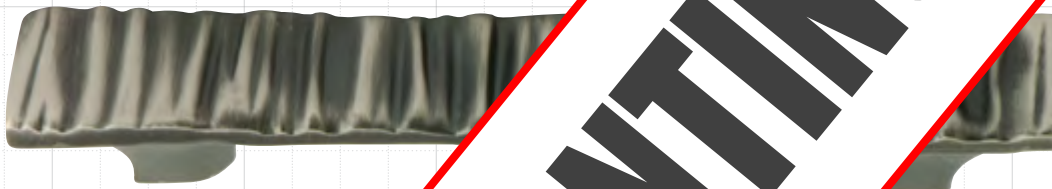

Theodora Pull

ANTIQUÉ PEWTER
80508BNBDL

W: 5 1/2"

Theodora Knob

ANTIQUÉ PEWTER
80508BNBDL

W: 1 1/4" H: 7/8"



Theodora Pull

SATIN NICKEL
80509-SN

W: 5 1/2" H: 3/4"

Theodora Knob

SATIN NICKEL
80508-SN

W: 1 1/4" H: 7/8"



 = 1/4 Inch



Judith Pulls & Knobs

AVAILABLE IN:

Antique Brass,

Antique Pewter,

Satin Nickel

Judith Knob

SHOWN IN ANTIQUE BRASS

OL: 1 1/2" OW: 1" P: 1" BD: 3/8"

Judith 9" Bow Pull

SHOWN IN ANTIQUE PEWTER

OL: 9" OW: 1" P: 1"

BD: 3/8" CC: 6 1/4"

Judith 7 1/2" Bow Pull

SHOWN IN ANTIQUE BRASS

OL: 7 1/2" OW: 1" P: 1"

BD: 3/8" CC: 5"

Judith 6" Bow Pull

SHOWN IN SATIN NICKEL

OL: 6" OW: 1" P: 1"

BD: 3/8" CC: 3 3/4"

OL Overall Length
OW Overall Width
P Projection
BD Base Diameter
CC Center to Center

OLD BISCAYNE DESIGNS

Claudette Medium 6" Pull

POLISHED BRASS

OL: 6" OW: 1 5/8" P: 1 1/4"

Claudette Small Pull

POLISHED BRASS

OL: 1 5/8" OW: 1 5/8" P: 1 1/4"



Claudette Large 12" Pull

POLISHED BRASS

OL: 12" OW: 1 5/8" P: 1 1/4"

ALSO AVAILABLE

Claudette Large 8" Pull

POLISHED BRASS

OL: 8" OW: 1 5/8" P: 1 1/4"

 = 1/4 Inch

OL | Overall Length
OW | Overall Width
P | Projection

Rev. 121719

70

1/2 1 1/2 2 3 3 1/2 4 4 1/2 5 5 1/2 6 6 1/2 7 7 1/2 8

Customer's Own Hardware

If you have a particular hardware that you want to send to have applied to an Old Biscayne design, please contact our customer service staff to confirm the size of the space.

1.800.397.5397

IT IS ESSENTIAL THAT HARDWARE FITS PROPERLY.

When specifying hardware other than the hardware pictured, please call for the up-charge.

OB

Biscayne Designs

1.800.397.5397

123 INDUSTRIAL BOULEVARD · AMERICUS, GEORGIA 31719

| WWW.OLDBISCAYNEDESIGNS.COM |